

## 4. Street Standards

**4.1.GENERAL** Designs for new streets and upgrades to existing streets in Steamboat Springs shall incorporate complete street concepts. Street design addresses safe and efficient movement of vehicles, pedestrians, bicycles, and transit while also incorporating landscaping, utilities, and storm drainage. Low impact drainage systems are encouraged where feasible. The street and trails network creates multiple travel routes and minimize the distance required for pedestrians and bicycles to access primary activity sites. This section sets forth the minimum standards for street design and construction. Developers and engineers are encouraged to design above the minimum standards and in some cases due to site specific conditions the City Engineer may require design above the minimum standards.

**4.2.STREET CLASSIFICATION.** Street classification for existing streets is generally established in the Community Plan, and for new streets classification is determined as part of the development approval process. The City transportation network includes conventional subdivision, old town commercial core, traditional neighborhood, trail, and private drives.

**4.2.1. Conventional Streets.** Conventional streets include the state highway and the street sections found in non-Traditional Neighborhood zoned areas of town. It generally includes the suburban and industrially zoned portions of town. Conventional Street cross-sections are presented in Appendix 4-A.

**4.2.1.1. State Highway.** US 40 is a federal route and a state highway under the jurisdiction of the Colorado Department of Transportation (CDOT). Design and access on the state highway is governed by the CDOT; refer to CDOT for US 40 design and access requirements. There is an Access Control Plan from 13<sup>th</sup> to the west urban growth boundary (UGB) that defines access type and locations along that corridor.

**4.2.1.2. Arterial.** An arterial street provides for travel through and between towns. These streets primarily serve through traffic, and access to adjacent property is limited. The arterial may include bike lanes and does include transit pull outs at bus stops. In addition to being a state highway, US 40 is classified as an arterial within the City.

**4.2.1.3. Collector.** A collector street provides a connection between arterials and local streets. The collector balances both through-travel needs and access to adjacent property. Residential lots (single family and duplex) do not access collectors. The collector typically includes bike lanes and transit pull outs at bus stops. There are two types of collector streets the Major collector and the Minor collector. The Major

collector typically provides access between arterials and developments and between adjacent developments. The Minor collector typically provides access between adjacent sites.

**4.2.1.4. Local Street.** A local street provides direct access from abutting properties to alley, collector, or arterial streets. While it provides for some through travel, the primary purpose is to provide access to individual properties. A sidewalk is provided on one or both sides depending on the zone district. The local street does not typically include bike lanes or transit pull outs at bus stops. There are three types of conventional local streets.

4.2.1.4.1. Local Street – Ditch is the typical rural street section with a street side ditch to manage drainage.

4.2.1.4.2. Local Street – Valley may be used where the smaller lot size makes it difficult to incorporate the standard street side ditch in between closely spaced driveways.

4.2.1.4.3. Local Street – Mountain section allows modifications intended to provide safe and reasonable access while minimizing the impact on the terrain. This section is intended for the areas of town where existing topography is steep (generally greater than 20 percent).

4.2.2. Old Town Commercial Core. The Downtown Streetscape plan identifies desired cross-sections for redevelopment of the old town commercial district. As redevelopment occurs or via a City project, old town commercial core streets shall be upgraded to meet the streetscape requirements. Appendix 4-B includes the streetscape plan.

4.2.3. Urban Streets. Urban streets encourage a pedestrian-oriented, interconnected environment. The urban cross-section correlates directly with the adjacent land use and transect zone. The locations and alignments of these streets are typically established in a land use designation or regulating plan in conjunction with the transect or future land use zoning and will be confirmed when actual land uses are identified. These standards list the typical land use designation and transects that are compatible with the street cross-section. If a street borders two different Land Use Designation or Transect Zones, the more intense Land Use or Transect Zone will determine the applicable street type. In some cases it may be appropriate to create a hybrid street with different streetscape elements (such as sidewalk and drainage) on each side of the street to match the adjacent land use. In those cases the ROW of the more intense use shall be used. Where on-street parking is permitted, the parking is intended to serve as extra guest parking and not serve as primary parking, except for daytime commercial uses. The parking will be restricted to daytime only during the period from November 1 to May 1

when overnight restrictions are in place. The cross-sections for the Urban Streets are shown in Appendix 4-C.

4.2.3.1. Boulevard. The Boulevard provides a primary route for vehicles and pedestrians between major arterials, such as U.S. 40, and primary mixed-use centers. It is designed to accommodate relatively high densities in a mixed-use environment, with wide sidewalks, on-street parallel parking, bike lanes, and a central median/turn lane. The Boulevard (Out-of-Town) is a more rural section with median, ditch, bike lanes, and detached walks for the transition between the arterial and the in town section.

4.2.3.2. The Parkway. The Parkway provides a primary route through mixed-use village centers. It is designed to accommodate relatively high densities in a mixed-use environment, with wide sidewalks, on-street parallel parking, designated bicycle lanes, and a central median/turn lane. The Parkway (In-Town) transitions to the Parkway (Out-of-Town) to provide a more fitting setting for lower density areas. Parkway (Out-of-Town) is designed to accommodate lower densities with drainage in open swales, narrower sidewalks, designated bicycle lanes, and no on-street parking.

4.2.3.3. The Connector. The Connector provides a primary route between the Parkway and surrounding areas as well as between development areas. The Connector (In-Town) is designed to accommodate primarily residential areas of moderate densities, with on-street parallel parking. The Connector (Out-of-Town) is designed to provide a more fitting setting for lower density areas along the same primary routes, with drainage in open swales and no on-street parking. Bike lanes may be required if the street alignment is part of the area-wide bike network.

4.2.3.4. The Drive. The Drive (In-Town) provides a primary route for vehicles and pedestrians between neighborhoods. It is designed to accommodate primarily residential areas of moderate densities, with on-street parallel parking. The Drive (In-Town) transitions to the Drive (Out-of-Town) to provide a more fitting setting for lower density areas along the same primary routes. It is designed to accommodate primarily residential areas of lower density, with drainage in open swales and no on-street parking as larger lots can accommodate parking on site.

4.2.3.5. The Neighborhood I. The Neighborhood I is an urban street section utilized in or adjacent to neighborhood centers. It is designed to accommodate moderate densities in a mixed-use environment, with wide sidewalks and on-street parking.

4.2.3.6. The Neighborhood II. The Neighborhood II is utilized in primarily residential areas of moderate density. This street has a detached walk with a landscape buffer and may have parking on one or both sides. Depending upon adjacent land uses, it may include a valley pan or ditch. On-street

parking should only be considered in areas where significant on-street demand is expected.

4.2.3.7. The Neighborhood III. The Neighborhood III is utilized in primarily residential areas of low density where defined on-street parking is not provided as all parking needs are accommodated on-site. This street has detached walk with a landscape buffer and may have a valley pan or ditch depending upon adjacent land uses.

4.2.3.8. The Alley. An alley provides rear access to lots and blocks. It provides a high level of access and very little through movement. New alleys shall be privately maintained. Sidewalks are not included in the typical cross-section and where needed to address Building Code requirements shall be located outside of the alley ROW. Bike lanes are not provided on alleys. Transit service will generally not access the alleys. There are three types of alleys: commercial, residential, and lane. The commercial and residential alleys do not provide primary Fire Department access, and lots with an alley on one side shall be served by a street on another side. The alley shall be designed to accommodate “yield” movement that limits vehicular speeds to less than 10 miles per hour. A Commercial Alley serves higher density mixed-use areas while the Residential Alley serves primarily residential areas. The Lane provides rear access and primary Fire Department access to lots fronting public open spaces instead of a street. Alleys are primarily located in the RN-3, RN-4, RO, CO, CY, CN, T5, T4-NC, T3-NG2, or the SD TND zoning transects, and are approved as part of the development application. For all three alley types a 5 foot snow storage easement on each side of ROW and a suitable snow storage easement (such as a pocket park or similar open space) at the end of the alley or across the street from the end of the alley are required to provide adequate snow storage. Fences and above ground features are not permitted in the 5 foot easements.

4.2.4. Sidewalk and Trail Classification. In addition to the Community Development Code, there are two master plans that identify requirements for sidewalks and trails. The Open Space and Trails Master Plan provides the general plan for trail connections, and the Sidewalk Master Plan provides the general plan for sidewalk connections. Specific locations of sidewalks and trails as well as the cross-section required will be determined during the development plan process. The cross-sections for the trails and more detailed cross-sections for the sidewalks are shown in Appendix 4-D. The sidewalk and trail cross-sections define a hierarchy of pedestrian and bicycle facilities designed to integrate alternate mode travel within the overall transportation system.

4.2.4.1. Pedestrian Paseos. Pedestrian Paseos are hard surface, year round maintained sidewalks utilized to provide a more direct pedestrian and bicycle connection where the street and adjacent alternate mode facilities are indirect. Paseos are sidewalks not adjacent to streets that are most

typically used in traditional neighborhood designs where topographic conditions or unique site conditions require longer than standard block lengths or in suburban neighborhoods where the street network does not provide frequent block connections. The paseo provides a designed way to “cut thru” a development, shortening alternate mode travel time.

4.2.4.2. Primary Trail. The primary trail provides a main thoroughfare through an area and between development areas and community destinations. The primary trail and supporting trails connect development areas to activity centers, community destinations, and parks and open space. It also serves as a recreation destination and commuting alternative for pedestrians, bicyclists, and other non-motorized users. The primary trail is preferred to be located along or within open spaces, greenways, or drainage corridors. The primary trail provides both a hard surface, year round maintained corridor and a soft surface non-winter maintained trail. This trail is classified as a shared use - multi-use facility and design should conform to the latest edition of the Colorado Department of Transportation Roadway Design Guide for Bicycle and Pedestrian Facilities

4.2.4.3. Secondary Trail. The secondary trail generally connects the primary trail to community destinations. It also provides connections between community destinations, neighborhoods, and parks and open space. Secondary trails are hard surface and are maintained year-round. Where the secondary connection route is adjacent to streets, the sidewalk system is considered the secondary trail connection and a separate trail is not required. This classifies as a shared – use, multi-use facility and design should conform to the latest edition of the Colorado Department of Transportation Roadway Design Guide for Bicycle and Pedestrian Facilities

4.2.4.4. Soft Surface Trail. The soft surface trail typically provides connections between neighborhoods, parks and open space, and secondary trails. It may also be used to provide seasonal connections within a development. In limited cases where alternative year round routes are provided, the soft surface trail may be approved by the Public Works Director as a secondary trail. The soft surface trail may be maintained year round, but typically is a seasonally maintained trail.

4.2.4.5. Back Country Trail. The back country trail is a natural trail corridor that primarily serves as a recreation destination for pedestrians, bicyclists, and other non-motorized users. This trail is located in undeveloped backcountry, open space, or rural areas.

4.2.5. Private Streets and Private Driveways. Private streets and driveways are not owned, maintained, or plowed by the City. They are the sole responsibility of the property owner. A private street or driveway that serves multiple lots is located in an easement or common area. The easement or common area width shall

accommodate the street width, drainage, construction requirements (slopes, etc), snow storage, sidewalks, bike facilities, transit service, and other appropriate design elements.. Cross parcel access easement shall not be less that 30feet wide. Sometimes a private street or driveway may be located in a public street ROW as allowed by an approved revocable license to outline private maintenance responsibility for improvements. Private driveway design shall also incorporate Fire Department design requirements and development code parking lot design requirements which are listed those respective standards and codes. The private driveway standards are summarized on Table 4.3 and in Appendix 4-E.

**4.2.5.1. Private Street.** A private street, sometimes referred to as a private road, is an access serving more than four units or lots that is not categorized as a private driveway. New private streets would constitute a variance to the Community Development Code and must first be approved by the Director of Community Development. Private Streets are discouraged because they create a cost burden to residents. Private streets shall meet the same design standards as public streets.

**4.2.5.2. Private Driveway.** A private driveway provides access from the street (public or private) to a lot or group of lots. The private driveway accommodates the identified design vehicle and appropriate alternate modes, drainage, utilities, and landscaping. There are three types of private driveways.

**4.2.5.3. Residential Private Driveway.** A driveway serving a single family residential unit, a single family residential unit with a secondary unit, an individual duplex, triplex, or fourplex or a combination of up to four units of any residential type is a residential private driveway.

**4.2.5.4. Residential Private Access.** A residential private access is the internal access drive system for a multi-family development and may include the driveway, access drives, and parking areas that serve the development. The Pines complex is an example of a residential private access.

**4.2.5.5. Commercial Private Access.** A commercial private access is the internal access drive system for a commercial lot or development and may include the driveway, access drives, and parking areas that serve the development. Wildhorse Marketplace is an example of a private access.

**4.3. DESIGN CONTROLS AND CRITERIA.** The cross-sections illustrate the design controls for each street, alley, trail, and private street section. A detailed discussion of each design control is not included in these standards. For more detailed information please refer to AASHTO. The following is additional detail for some city-specific items.

**4.3.1. Design Vehicles.** The street design shall accommodate the turning movements of the design vehicle as listed on the design tables. The design should allow the

design vehicle to make turns at intersections without encroaching into the oncoming lanes. The need for vehicles greater than the design vehicle to turn into oncoming lanes shall be reviewed and the design modified if appropriate. Existing, proposed, or potential future transit routes as determined by the Transit Superintendent shall be designed to accommodate the design transit vehicle. The design engineer shall confirm that any Fire Department turning requirements are also met. In accordance with the Institute of Transportation Engineers Urban Street Geometric Design Handbook guidance, the type of area and the frequency of use by different vehicle types should be reviewed, and it may be acceptable to allow an infrequent vehicle type to cross over the street centerline on lower volume, slower speed streets.

- 4.3.2. Sidewalks. Sidewalks, trails, and pedestrian access shall be provided as identified in the Community Development Code (CDC), the Sidewalk Master Plan, or other applicable requirements. Where outside of the ROW, the sidewalk shall be in a public access easement that is of sufficient width to allow for repairs to the sidewalk, accommodate any drainage, and allow for installation of any required signs.
- 4.3.3. Bicycle Facilities. Bicycle facilities shall be installed per the CDC, the Open Space and Trails Plan, the Bicycle Community Plan, and any other applicable requirements. Where outside of the ROW, the bicycle facility shall be in a public access easement of sufficient width to allow for repairs to the facility, accommodate any drainage, and allow for installation of any required signs. Bicycle facility design should follow the AASHTO Guide for the Development of Bicycle Facilities, current edition and the Colorado Department of Transportation Roadway Design Guide for Bicycle and Pedestrian Facilities
- 4.3.4. Transit Facilities. Streets shall be designed to accommodate transit facilities where transit routes are identified during the development process. Transit stops shall be located to minimize impact on through traffic, provide efficient arrival and departure for the transit vehicle, and bear a logical relationship to the population served. New transit stops and facilities shall be connected to the adjacent developments via sidewalks and trails.
- 4.3.5. Pedestrian Crossing Enhancements. Pedestrian crossing enhancements are encouraged where feasible and when applicable warrants are met as identified in Chapter 6.4.5 of the City Standards. Other considerations for installation include cost of maintaining the improvement and benefit of the enhancement. A need for pedestrian crossing enhancements will be evaluated during the development process. Enhancements are required where new mid-block and unprotected crossings are proposed and warrants are expected to be met. . They are also encouraged at primary trail crossings at controlled intersections. Bulb outs are required in some urban street sections to shorten pedestrian crossing time. Design should conform to the latest edition of the Colorado Department of Transportation Roadway Design Guide for Bicycle and Pedestrian Facilities

**4.4.DESIGN ELEMENTS.** The alignment of a street should be selected to minimize the impact on the environment, provide a safe travel way, and provide an interconnected network. Streets should be designed to blend into the surrounding slopes. Tables 4.1 through 4.3 summarize the public and private street design parameters.

- 4.4.1. Design Limits. Where a new street, sidewalk, or trail terminates at property limits, but will ultimately be extended, the street, sidewalk, or trail shall be conceptually designed to the nearest intersecting street or until existing grades are met to show that the proposed design can be extended in the future.
- 4.4.2. Horizontal Alignment. Street layout is designed to bear a logical relationship with the topography, connect to existing and planned area streets, provide reasonable access to adjacent parcels, and follow the general patterns identified in City master plans. Street layout shall be designed to fit the context of the development and serve vehicle, pedestrian, transit, and bicycle users. Street layout shall avoid long, straight sections to minimize the potential for speeding.
- 4.4.3. Super elevation. Collector and local streets utilize standard crown sections and do not include super elevation. Super elevation may be considered on collector and local streets in limited instances to address unique drainage or grade issues. At intersections, grades of the minor street shall be warped to transition to the grades of the major street.
- 4.4.4. Vertical Alignment. The design should take into consideration the impact the vertical grade has on the operation of the facility.
- 4.4.5. Combinations of Horizontal and Vertical Alignment. Wherever design includes both vertical and horizontal curves in close proximity, vertical curves should be superimposed on horizontal curves to reduce the number of sight distance restrictions. Horizontal and vertical curves shall be as flat as physical conditions permit.
- 4.4.6. Switchbacks. Switchbacks, a series of back to back curves to reduce street grades on inclines, are not recommended and require the approval of the City Engineer. Switchbacks should only be considered for mountain local streets with low volumes (less than 1,500 vehicles per day). The minimum circular curve radius for any switchback is 80 feet. To accommodate the shorter radius, the maximum grade through a switchback curve shall be five percent, and the grade used on the switchback shall be continued beyond the switchback into the tangent so the vertical curve lies off the switchback. Additional mitigating design elements such as curve widening and increased stopping sight distance may be required.
- 4.4.7. Public Streets. Public Streets are owned, maintained, and plowed by the City. Public streets are located in right of way as dedicated to the public. Right of way



width or appropriately dedicated public easements shall encompass the extent of the improvements associated with the roadway geometry and cross section and those areas necessary to perform long term maintenance operations. This includes but is not limited to the street width, drainage, construction requirements (slopes, etc), snow storage, sidewalks, bike facilities, transit service, and other appropriate design elements. When cut and fill slopes are necessary for roadway construction, dedication of right of way or easement shall be determined based on the toe of fill slope and/or top of the cut slope.

- 4.4.8. Block Length. The municipal code provides requirements for block length. This portion of the engineering standards identifies the process to evaluate variance requests to changes to block length due to design limitations from topography or unique site constraints. In these cases the designer shall work with the Public Works Director to evaluate the benefits and impacts of the proposed variance on the different design elements and to identify mitigation measures. Recognizing that modifications to block length standards may require tradeoffs in design elements, priority shall be given to the following:
- o Modification of site layout to meet block length standards
  - o Pedestrian and bike connectivity
  - o Vehicular connectivity
  - o Preservation of natural features
  - o Minimizing overlot grading/ fitting features to terrain
  - o Creating/maintaining open space
- 4.4.9. Cul-de-sac. Dead end streets are discouraged and shall be avoided unless topographic or other unique site constraints limit construction of interconnected streets. The design of cul-de-sacs will be reviewed following the criteria listed in Section 4.4.8 for Block Length variances. Any public street or private street that dead ends shall terminate in a cul-d-sac. Driveways may terminate in an alternate configuration, such as a hammerhead, meeting Fire Department requirements. Appendix 4-F provides the standard cul-d-sac layout. All cul-de-sac's shall include signage within fifty feet of the inlet indicating that the street is a dead end street.
- 4.4.10. One Way Streets. One-way streets are discouraged due to the restriction they place on the motorist and the potential need for additional travel. They require unique site circumstances to be considered and the approval of the City Engineer. A one-way street width shall be 16 - 20 feet wide exclusive of on street parking; with 20 feet required where street is a primary fire access.
- 4.4.11. Alleys. Alleys are used where approved as part of a development plan in Old Town and in some TND Zone districts. The maximum alley length shall be per the requirements of the CDC, and should be a maximum of 600 feet. The cross slope shall be 2 to 3 percent. The minimum grade shall be 2 percent with a

maximum grade of 5 percent. There may be limited cases where 7 percent may be approved for portions of the alley by the Public Works Director where the alley has sun exposure and a maximum of 4 percent within 25 feet of the connecting street. The curb radius on the alley should be 15 feet for the commercial alley and rear lane and may be reduced to 5 feet for the residential alley.

- 4.4.12. Horizontal Clearance to Obstructions. All fixed objects should be located outside the clear zone as defined in the AASHTO Roadside Design Guideline. The design should provide a clear zone as wide as practical within constraints per the latest version of the AASHTO Roadside Design Guidelines. A For low speed, low volume roadways a minimum clear recovery zone area of 6 feet in width shall be provided for roadways without curb and 2 feet in width for all roadways with curb.
- 4.4.13. Vertical Clearance to Obstructions. Generally private overhead structures are not permitted in the public ROW and consideration of such structures shall be limited. Signal height clearances shall be per the current MUTCD. For other structures there shall be a minimum 16 foot clearance on streets.
- 4.4.14. Clear Sight Triangle. On corner lots adjacent to streets a clear sight triangle of unobstructed vision shall be provided. Within the clear sight triangle, no building, structure, vegetation, fence or other feature shall obstruct the area between 3 feet in height and 8 feet in height within a triangular area measured by two lines along the property line for a distance as specified by AASHTO based on the speed of the street and the type of control. Street trees and poles less than 12 inches in diameter may be permitted.
- 4.4.15. Traffic Barriers. The installation of guardrails on embankments and adjacent to fixed objects may reduce the combined effect of severity and frequency of “run-off-road” type accidents. Guardrails reduce accident severity only when the overall severity of striking the guardrail is less than the severity of going down an embankment or striking a fixed object. They should not be installed if they are likely to create a greater hazard than running off the street. Evaluating installation of guardrails shall consider accident experience, street objectives, functional classification of streets, design speed, traffic volume and type, street cross section, height of embankment, steepness of fill slope, horizontal curvature, gradient or profile conditions, street side conditions, climatic conditions, and degree of projected injury from traveling off the street.
- 4.4.16. Medians. Medians other than those listed within the street cross-sections are generally not permitted on new City streets, and must be approved by the City Engineer. Medians shall be designed with plowable noses.

4.4.17. Survey Monuments. All horizontal and vertical monuments shall be established by a Land Surveyor registered in the State of Colorado in accordance with the Colorado Revised Statutes.

4.4.18. Utilities

4.4.18.1. Location. Utility lines shall be located to minimize the need for future adjustment and shall consider future extensions of the street system. Project Engineer shall coordinate with utilities and Public Works Director to determine if additional conduit is required to provide for future utility crossings. To the extent practical, utility crossings of a street shall be perpendicular to the street. Water and Sewer shall be located per the Water districts requirements and should be within the street ROW. Dry utilities may be located within the ROW or within a utility easement with adequate clearance provided between the separate utilities. Above ground utilities shall not be located within or conflict with the street side drainage ditch. Any above ground appurtenances shall be sufficiently offset from the pavement to provide adequate clear distance and to not interfere with snow plowing operations. Utilities in the ROW shall be buried a minimum of 2 feet below street subgrade.

4.4.18.2. Service Stub Outs. For all residential lot subdivisions or any subdivision containing lots less than 14,000 square feet, all utility service connections and stub outs located beneath a future public street shall be installed prior to pavement placement

4.4.19. Snow Storage. Street and driveway design shall provide snow storage areas.

The snow storage easements not specified on the street cross-section shall be sized according to Section 26-142 of the CDC. The standard ROW cross-section provides the minimum desired snow storage of ten feet. Additional snow storage easements for public streets may be required based on terrain and street classification, and shall be identified as part of the design. Alleys require pocket snow storage and utility easements along the alley and at the end of each alley. Site design shall include sufficient snow storage areas for driveways, parking areas, and sidewalks sized per the CDC requirements. All snow storage areas shall be located and sized to be reasonably used by typical plowing equipment. Hauling is discouraged. Private snow melt systems may be considered for private driveways or sidewalks with restricted snow storage; but snow melt may not be used for public streets.

4.4.20. Mail Boxes. Cluster mail boxes shall be located in coordination with the local Post Master. Boxes should not be located on arterial or collector streets.

Cluster boxes shall be placed on the right side of the street, off a minimum 8foot wide turnout. The turnout is recommended to be paved, but may be a wide shoulder. The turnout shall be located with consideration for walking access, sight distance, and a sufficient distance away from intersections and driveways. The location of the cluster box shall accommodate street plowing and snow storage. The City is not responsible to plow the turnout.

- 4.4.21. Parking. See CDC for detailed parking requirements. Any commercial or multifamily driveway shall be designed so backing out onto a street is not required. Residential driveways may be designed to permit backing out onto local streets only. Parking stalls along driveways shall be located a sufficient distance from the street to prevent parking maneuvers from blocking the access or queuing from blocking the parking spaces.
- 4.4.22. Pavement. The street pavement design evaluation shall be established for each project in a geotechnical report following the latest CDOT procedures and practices. For public streets the minimum section thickness shall be 8 inches of Class 2, 4 inches of Class 6, and 4 inches of asphalt placed in 2 inch lifts or equivalent. For existing or proposed streets that are not expected to be subject more than an equivalent loading of 500 passenger vehicles per day based on a 20 year projected volume and that does not constitute a future pass through roadway for future development, a street pavement design evaluation is not required and the minimum design section is considered appropriate. Private streets and driveways may be asphalt, concrete, or other impervious surface approved by the Public Works Director. Sidewalks and bus pullouts shall be concrete. The pavement thickness shall be based on the 20 year design volumes as identified by the more current of the site's approved traffic study or an adopted City Master Plan. Where 20 year projected volumes are not available, the threshold volume for a local street shall be 2,500 vehicles per day and for a collector street shall be 16,000 vehicles per day.
- 4.4.23. Traffic Control. Traffic control designs shall be prepared by a Colorado licensed professional engineer experienced in traffic engineering. The designs shall be prepared in accordance with the latest version of the Manual on Uniform Traffic Control Devices (MUTCD).
- 4.4.23.1. Signals. Traffic signals shall be installed at locations approved the City or CDOT, and as identified as meeting warrants in the traffic impact study. Design of all traffic signals shall be in accordance with the MUTCD and the CDOT standards and Specifications. Signal design shall be reviewed with the Fire Marshall to determine if Opticom is required. All signal poles, mast arms, and signal heads shall be appropriately powder coated and painted black
- 4.4.23.2. Signing and Striping. Within the Base area, directional signing shall follow the specifications of the Base Area design standards.

#### 4.4.24. Sidewalks and Trails

- 4.4.24.1. Grades. Sidewalks and paseos should be designed with a minimum grade of 1 percent and a maximum grade of 5 percent. Steeper slopes may be considered where permitted by American Disability Act (ADA) standards. The maximum grade for primary and secondary trails is 8 percent, with a target of 5 percent maximum where feasible. The backcountry and soft surface

trail grades should be minimized as much as possible with a recommended average grade of 10 percent and a maximum of 8 percent for ADA accessible trails. On hiking only backcountry trails, steps may be required to maintain 10 percent maximum slope.

4.4.24.2. Vertical Clearance. Vertical clearance for sidewalks should be 8 foot minimum and for shared use paths should be 10 foot minimum

4.4.24.1. Horizontal Clearance. A minimum of 3 feet horizontal clearance should be provided to obstructions.

4.4.24.2. Curb Ramps. Curb Ramps on sidewalks shall be designed to comply with ADA standards including detectable warnings. Where feasible separate ramps shall be provided for each crossing direction. Where site constraints prohibit separate ramps a single multidirectional ramp may be used. Refer to CDOT for ramp details. The standard detectable warning shall be East Jordan Ironworks cast iron, natural finish plates or approved equal.

4.4.24.3. Steps. Steps are not permitted on public sidewalks and trails (except backcountry trails). Grades shall be designed to accommodate ADA requirements. This may require building accesses to be recessed. Steps are discouraged but allowed on private walks provided ADA accessible routes are provided.

4.4.24.4. Guardrails and Handrails. The need for guardrails and handrails on public sidewalks and trails shall be evaluated based on the building code, AASHTO, ADA guidelines, and Colorado Department of Transportation Roadway Design Guide for Bicycle and Pedestrian Facilities and the determination for installation made in consultation with the designer and the City Public Works Director. Railing height (typically 42” or 54”) shall be determined based on the potential hazard and sidewalk/trail user type.

4.4.24.5. Curves. Sidewalks and trails may meander and curves shall be designed for the intended users and speeds. Easements may be needed to allow meandering and provide the required minimum offset from the street to allow for snow storage and drainage.

4.4.24.6. Old Town Commercial Core. Refer to Downtown Design Guidelines for streetscape plan within the Downtown Core.

4.4.24.7. Offset. Detached sidewalks and trails adjacent to street shall have the minimum offset identified in the street cross-sections or 10 feet from edge of pavement. To avoid existing objects or provide meandering, sidewalks and trails should be detached farther from the street, not closer. Sidewalks and trails should be offset 2 feet minimum from horizontal obstructions such as light poles or fences.

4.4.24.8. Drainage. Drainage from large surrounding areas across sidewalks should generally be prevented. Trail construction should include appropriate drainage diversions to minimize trail maintenance and foster drainage away from or off the trail.

4.4.24.9. Lighting. Lighting for trails should be evaluated based on safety and the type of trail. Lighting will generally be required for primary trails at primary trailheads, underpasses, mid-block crossings. Where sidewalks and trails are located near or adjacent to streets, lighting shall be coordinated with street lighting requirements.

4.4.24.10. Waysides. Trail waysides are refuge areas alongside the trail to provide areas for resting or congregating outside of the trail corridor. On primary trails major waysides are located approximately one per mile or as utilities are available, and minor waysides are located approximately every one half mile. Where possible, waysides should be combined with trailheads or trail connections. On secondary trails, minor waysides are recommended every ½ mile. Minor waysides are recommended at areas of visual or interpretive interest on backcountry and soft surface trails.

4.4.24.11. Signs and Striping. Traffic control signs and striping shall be included for pedestrian facilities in accordance with the MUTCD, AASHTO, and city guidelines. Wayfinding signs may be required on primary and secondary trails to direct alternate mode users to community destinations.

#### 4.4.25. Bicycle Facilities.

4.4.25.1. Bike Railings. Railings shall be provided on trails and sidewalks where the grades require a railing per the building code, ADA or unique hazards exist that would be minimized by the installation of a railing. Railing height (minimum 42") shall be determined based on the type of potential hazard.

#### 4.4.25.2. Bike Racks (located in public right of way)

4.4.25.2.1. The exterior surface of the bike rack shall be non-abrasive, non-marring and durable. The coating durability implies that routine maintenance is unnecessary.

4.4.25.2.2. There shall be at least thirty (30) inches between bike racks.

4.4.25.2.3. The bike racks shall be located at least twenty-four (24) inches from a sidewalk or vehicle travel surface.

4.4.25.2.4. Unless an alternative rack design is approved by the Director of Planning, the standard bike rack shall be the inverted "U" design. This inverted "U" shall be comprised of a single tube, two-inch diameter minimum, bent to a single arc which smoothly flows into the straight post sections of the inverted "U". The minimum height for the inverted "U" shall be thirty-six (36) inches from base to top of "U".

#### 4.4.26. Transit Facilities.

**4.4.26.1. Transit stops.** Where required by the Public Works Director, transit stops shall be located where direct pedestrian access is provided from the street and adjacent sidewalk or surrounding area to the stop. Transit stops shall include a paved waiting area with a direct connection to the adjacent sidewalk. As each site is unique, the waiting area dimensions shall be determined by the Public Works Director.

**4.4.26.2. Bus shelters.** The location of Bus shelters shall be determined by applicable Transportation Master Plans or by the Public Works Director. Shelters shall be located to provide ADA access and to not obstruct sight distance. A 6 inch thick concrete pad shall be located under all bus shelters. The pad shall extend at least 2 feet past the edges of the shelter and generally be 16 feet by 8 feet. Shelters next to detached walks shall include a concrete area between the street and the walk as a loading area with ADA compliant connection between the loading area and the adjacent sidewalk. Shelters shall include one bear resistant trash container, one recycling container, and one bicycle rack. Shelter design shall be approved by the Director of Public Works and shall generally be 12 ft wide by 6 ft deep with access to the front and 8 inch clearance from the bottom to the concrete pad to allow for drainage flow.

**4.4.26.3. Bus pull outs.** Bus pull outs shall be designed to provide a 30 foot loading area per bus, a 5: 1 entering, and a 5:1 exiting taper. The exiting taper may be reduced to 3:1 to address design constraints. The pavement in the bus pull out lane shall be designed per a pavement evaluation report to account for the expected bus traffic; minimum concrete thickness of 10 inches shall be provided.

**4.5.PRIVATE ACCESS CRITERIA.** The criteria for private accesses are listed in Table 4.3. Additional design parameters and clarifications are described in the following sections.

**4.5.1. Number.** Only one driveway shall be provided per lot. Where topographic or other site conditions exist, shared driveway between lots may be required. A second driveway may be approved to a lot where the following conditions can be met:

- o The property has frontage that will allow a minimum separation between adjacent or opposing accesses or streets measured from edge of travel lane to edge of travel lane of:
  - 50 feet for residentially zoned parcels or 150 feet for commercial and multifamily zoned parcels on a local street,
  - 300 feet on a collector street, and
  - 600 feet on an arterial or greater if required by a traffic study;
- o For a collector or arterial street frontage wherein a traffic impact study demonstrates a need for a second access based on traffic volumes,

unique site constraints or site requirements that generates the need for the second access;

- o Existing commercial or multifamily sites with multiple access points are required by Fire or the approved traffic study;
- o No feasible design alternatives are available to eliminate the need for a second access.

Alley access is not available. The above conditions do not apply to lots with alley access – in this case all access to the lot shall be from the alley

More than one driveway can be approved if:

- o The parcel served is a duplex lot, frontage is available to locate two separate 12 - 24 foot driveways meeting driveway standards that are offset 10 feet min (25 feet recommended) from each other, offset 25 feet min. from adjacent driveways, adequate snow storage can be provided, the driveways are 10 feet min from the property line, and due to slopes or other site constraints the building cannot be setback to accommodate turning movements for a single access.
- o A secondary access is required to meet Fire Department requirements and design requirements are met, or

In all instances adequate sight distance shall be provided at the second access and all accesses shall be constructed to meet City private access standards.

4.5.2. Configuration. Angle of access approach to street should be perpendicular. A maximum deviation from perpendicular of 30 degrees may be considered to accommodate grade constraints or other site specific considerations. Circular driveways are not permitted. Existing circular driveways or multiple driveways shall be reduced to a single access in conjunction with a significant remodel, an addition, or garage construction. Exception: circular access constructed as part of a Porte-cochere may be considered if the following criteria are met: G1 or G2 zoned parcel, access is one-way, access locations are separated by a minimum of 50 feet, required offsets to adjacent access and streets are provided, and the Porte-cochere area provides sufficient pick up/ drop off queuing area as determined by a traffic study.

4.5.3. Location. Private access shall be from the lowest classification street. Lots with alley frontage shall have access from the alley only. When sites adjacent to an alley redevelop, propose a significant remodel or addition, or add a secondary unit, accesses and parking on an adjacent street shall be removed and access shall be solely from the alley. Driveways on a cul-d-sac shall be located to provide room for snow storage and shared access may be required. Exception: where there is an existing garage served by the street that shall remain without changes, the street access can remain to serve the garage. If feasible that access should be upgraded to meet current standards.

4.5.4. Grade. Refer to Table 4.3

4.5.5. Width Refer to Table 4.3



- 4.5.6. Surface. All private commercial, industrial, and multi-family access shall be paved. Pavement placement shall occur prior to issuance of certificate of occupancy or sooner if required to meet Fire Department or utility requirements. All private streets or accesses serving more than four units or lots shall be maintained in proper working condition to prevent potholes and overall surface deterioration. Private residential access should be paved within one year of project completion. All access and parking areas shall be paved with asphalt, concrete, recycled asphalt, or other all-weather drivable surface approved by the City Engineer. A pavement apron a minimum 50 foot long by the adequate width shall be provided immediately adjacent to a private or public street for any proposed all weather surface access or storage area contained on the private parcel. Concrete driveways shall either a) terminate 4 feet from the edge of asphalt on Public Streets and a 3" thick (min) asphalt apron shall be constructed between the concrete driveway and the public street., or b) concrete can be placed to the edge of asphalt if it is even with or 1 inch lower than the top of asphalt, and an expansion joint is provided between the asphalt/concrete interface.
- 4.5.7. Heated Driveways. Driveway heat systems shall terminate at the property line with no components located in the right-of-way unless snowmelt within the ROW has a separate zone created for the portion of the system located within the right-of-way, snowmelt stops 5 feet from the street or other accommodations are made to reduce the impacts of the snow/melted interface, and a revocable permit filed for the system is filed prior to building permit.
- 4.5.8. Underground garages. Access to underground garages shall have a maximum slope difference between the access transitions and landings of 8% to avoid vehicle scraping. The maximum slope for a covered underground garage access is 16%, excluding the 4% maximum within 15 feet of the public access.

## Appendix 4-A – Conventional Street Cross-Sections

Blank – to be added in future

**Appendix 4-B – Old Town Cross-Sections  
(See Downtown Streetscape plan)**

## Appendix 4-C – Urban Street Cross-Sections

Boulevard - Out of Town

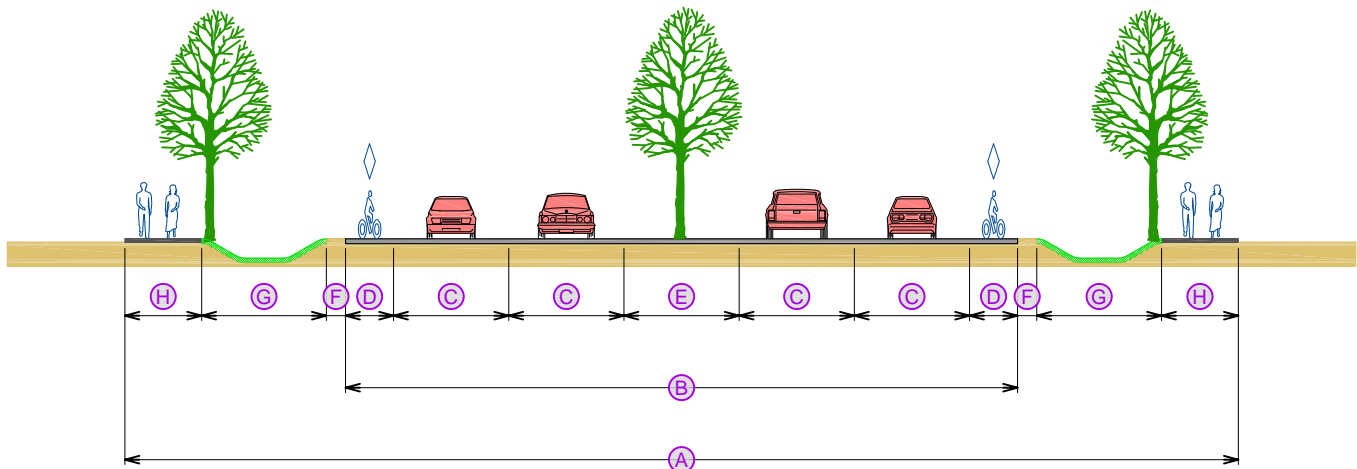

Application	
Design / Posted Speed	35 mph / 25 mph
Typical Transect Zone	T5
Overall Widths	
Right-of-Way (ROW) Width <sup>1,2</sup>	116' (A)
Curb Face to Curb Face Width	70' (B)
Lanes	
Traffic Lanes <sup>1</sup>	4 @ 12' (2-way travel) (C)
Bicycle Lanes	2 @ 5' (D)
Parking Lanes	None
Medians / Snow Storage	12' median / turn lane (E)

<sup>1</sup>Traffic Lanes and ROW may be reduced from 4 to 2 lane section as determined by an approved traffic study.

<sup>2</sup>Auxiliary lanes, as determined by traffic study, may require additional ROW.

Additional paving required for 10' transit stops.

Edges	
Street Edge	2' shoulder (F)
Planter Type / Drainage	13' swale / landscape (G)
Landscape Type <sup>3</sup>	Medium trees @ 35' o.c. avg.
Pedestrian Lighting Type <sup>4</sup>	Single column @ 50' o.c.
Walkway Type	8' sidewalk (H)
Intersection	
Curb Radius <sup>5</sup>	15'
Design Vehicle	WB 50
Pedestrian Enhancement	Concrete crosswalks at controlled intersections

<sup>3</sup>Trees may be clustered.

<sup>4</sup>Street lights may be required at arterial and collector intersections.

<sup>5</sup>Or as required to accommodate design vehicle and/or transit

Utility easements may be required.

Boulevard - In Town

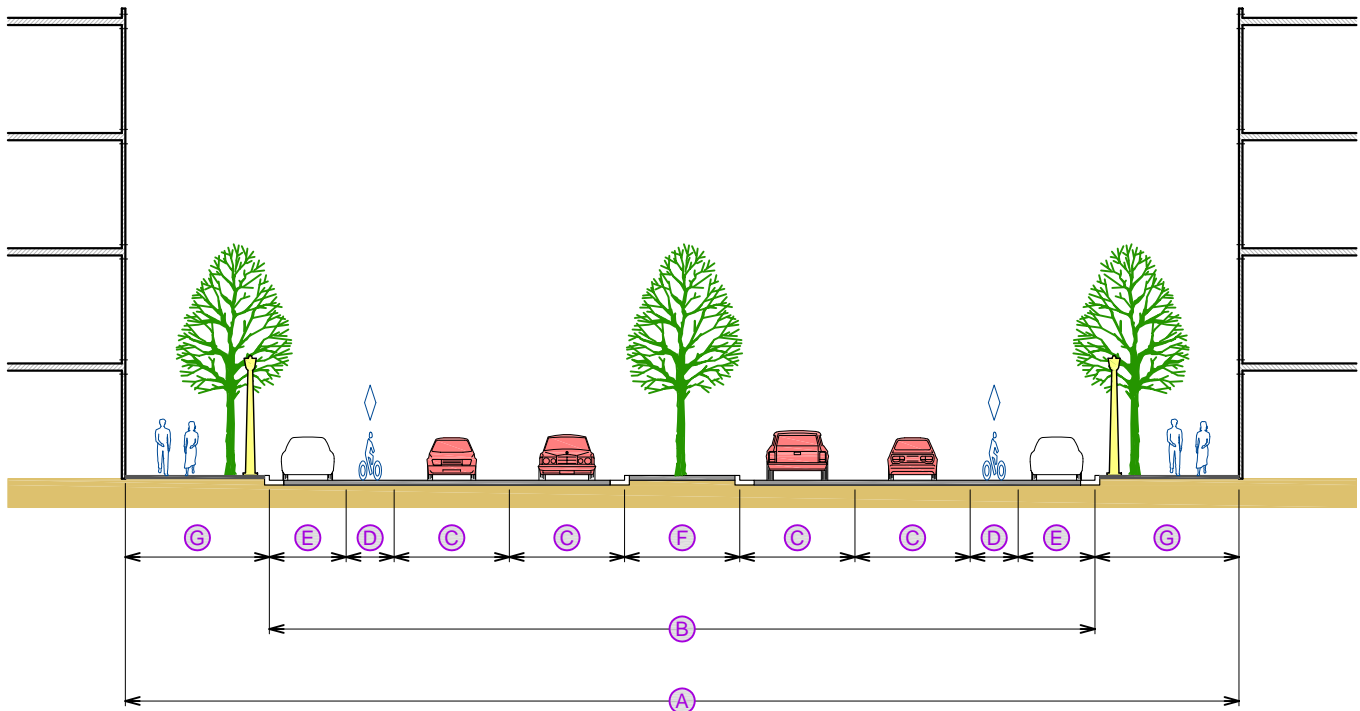

**Application**

Design / Posted Speed	25 mph / 25 mph
Typical Transect Zone	T5

**Overall Widths**

Right-of-Way (ROW) Width <sup>1,2</sup>	116'	(A)
Curb Face to Curb Face Width	86'	(B)

**Lanes**

Traffic Lanes <sup>1</sup>	4 @ 12' (2-way travel)	(C)
Bicycle Lanes	2 @ 5'	(D)
Parking Lanes <sup>3,4</sup>	2 @ 8' parallel	(E)
Medians / Snow Storage	12' median / turn lane	(F)

<sup>1</sup>Traffic Lanes and ROW may be reduced from 4 to 2 lane section as determined by an approved traffic study.

<sup>2</sup>Auxiliary lanes, as determined by traffic study, may require additional ROW.

<sup>3</sup>Transit stops are accommodated within parking lanes in locations approved by the Public Works Director; sidewalk width reduced by 2' at transit stop locations for 10' transit lane.

<sup>4</sup>No overnight parking during winter restricted hours.

**Edges**

Street Edge / Drainage	Vertical curb and gutter
Planter Type	4' x 4' tree grates
Landscape Type	Medium trees @ 35' o.c. avg. None along galleries / arcades.
Pedestrian Lighting Type <sup>5</sup>	Single column @ 50' o.c.
Walkway Type	15' sidewalk (G)

**Intersection**

Curb Radius <sup>6</sup>	15'
Design Vehicle	WB 50
Pedestrian Enhancement <sup>7</sup>	Bulb outs; Concrete crosswalks at controlled intersections

<sup>5</sup>Street lights may be required at arterial and collector intersections.

<sup>6</sup>Or as required to accommodate design vehicle and/or transit

<sup>7</sup>Parking eliminated and width of paving reduced at intersection to decrease pedestrian crossing distance.

Utility easements may be required.

Parkway - Out of Town

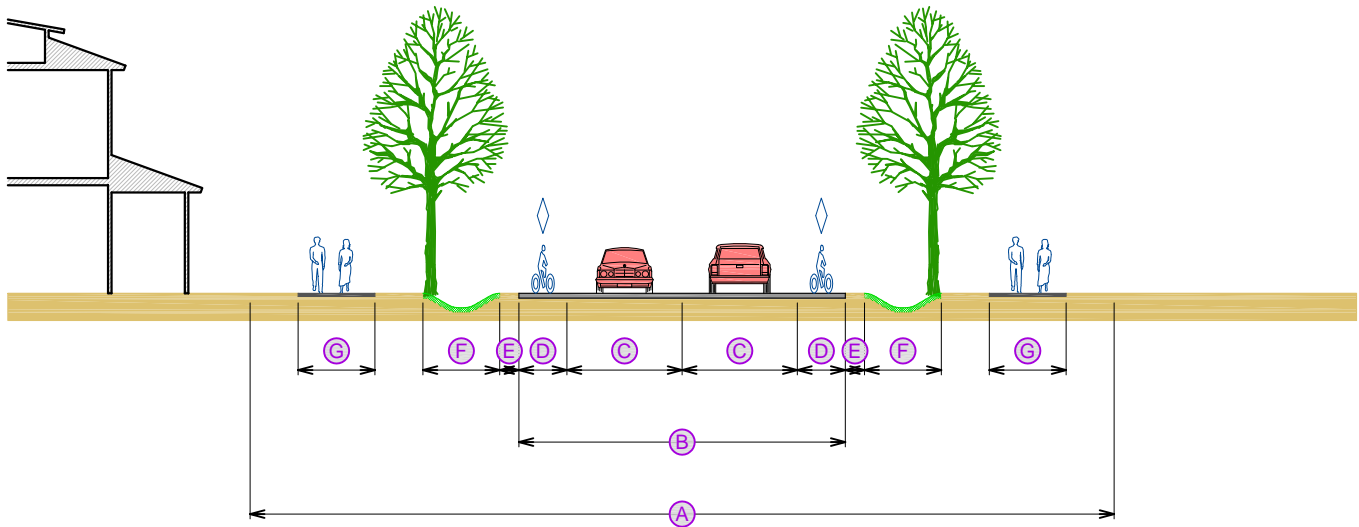

**Application**

Design / Posted Speed	25-35 mph / 25-35 mph
Typical Transect Zone	T3, T2, SD, OT

**Overall Widths**

Right-of-Way (ROW) Width <sup>1</sup>	90'	(A)
Pavement Width <sup>2</sup>	34'	(B)

**Lanes**

Traffic Lanes	2 @ 12' (2-way travel)	(C)
Bicycle Lanes	2 @ 5'	(D)
Parking Lanes	None	
Medians	None	

<sup>1</sup> Auxiliary lanes, as determined by traffic study, may require additional ROW.

<sup>2</sup> Pavement width may widen to accommodate transit stops in locations approved by the Public Works Director.

**Edges**

Street Edge <sup>3</sup>	2' shoulder	(E)
Planter Type / Snow Storage / Drainage	8' swale / landscape	(F)
Landscape Type <sup>4</sup>	Large trees @ 40' o.c. avg.	
Pedestrian Lighting Type	None	
Walkway Type	8' sidewalk	(G)

**Intersection**

Curb Radius <sup>5</sup>	15'
Design Vehicle	WB 50
Pedestrian Enhancement	Concrete crosswalks at controlled intersections

<sup>3</sup> Shoulder used to provide 10' required width for snow storage.

<sup>4</sup> Trees may be clustered.

<sup>5</sup> Or as required to accommodate design vehicle and/or transit Utility easements may be required.

Parkway - In Town (Village Center)

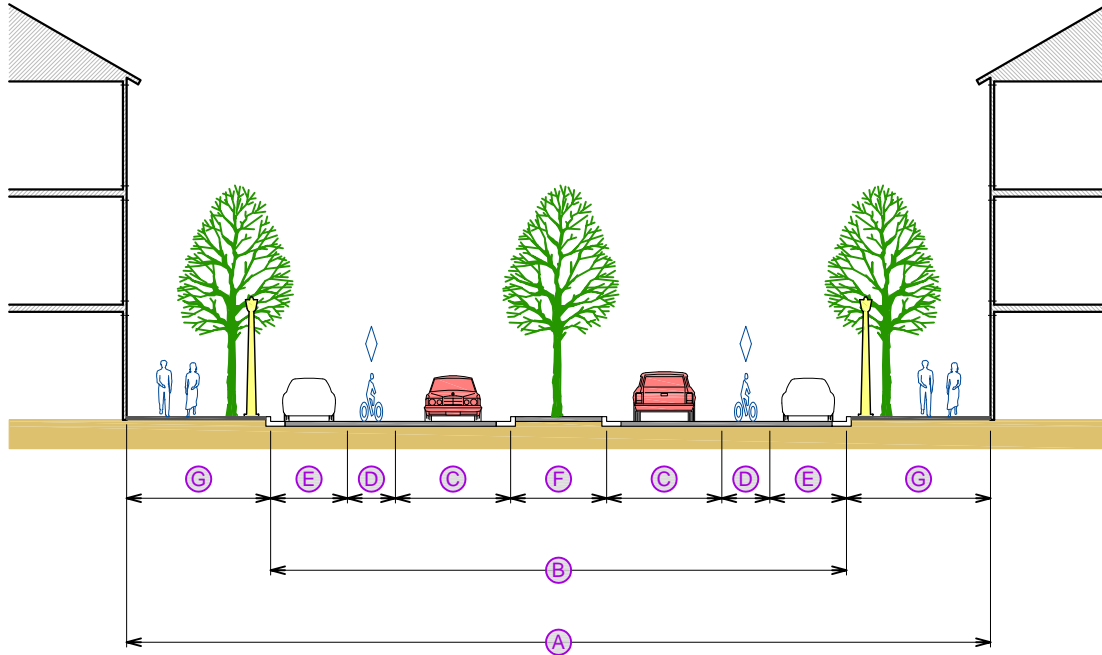

Application	
Design / Posted Speed	25 mph / 25 mph
Typical Transect Zone	T4, T5
Overall Widths	
Right-of-Way (ROW) Width <sup>1</sup>	90' (A)
Curb Face to Curb Face Width	62' (B)
Lanes	
Traffic Lanes	2 @ 12' (2-way travel) (C)
Bicycle Lanes	2 @ 5' (D)
Parking Lanes <sup>2, 3</sup>	2 @ 8' parallel (E)
Medians / Snow Storage	10' median / turn lane (F)

<sup>1</sup> Auxiliary lanes, as determined by traffic study, may require additional ROW.

<sup>2</sup> Transit stops are accommodated within parking lanes in locations approved by the Public Works Director; sidewalk width reduced by 2' at transit stop locations for 10' transit lane.

<sup>3</sup> No overnight parking during winter restricted hours.

Edges	
Street Edge / Drainage	Vertical curb and gutter
Planter Type	4' x 4' tree grates
Landscape Type	Medium trees @ 35' o.c. avg. None along galleries / arcades.
Pedestrian Lighting Type <sup>4</sup>	Single column @ 50' o.c.
Walkway Type	15' sidewalk (G)
Intersection	
Curb Radius <sup>5</sup>	15'
Design Vehicle	WB 50
Pedestrian Enhancement <sup>6</sup>	Bulb outs at street intersections. Concrete crosswalks at controlled intersections

<sup>4</sup> Street lights may be required at arterial and collector intersections.

<sup>5</sup> Or as required to accommodate design vehicle and/or transit

<sup>6</sup> Parking eliminated and width of paving reduced at intersection to decrease pedestrian crossing distance.

Utility easements may be required.



Connector - Out of Town

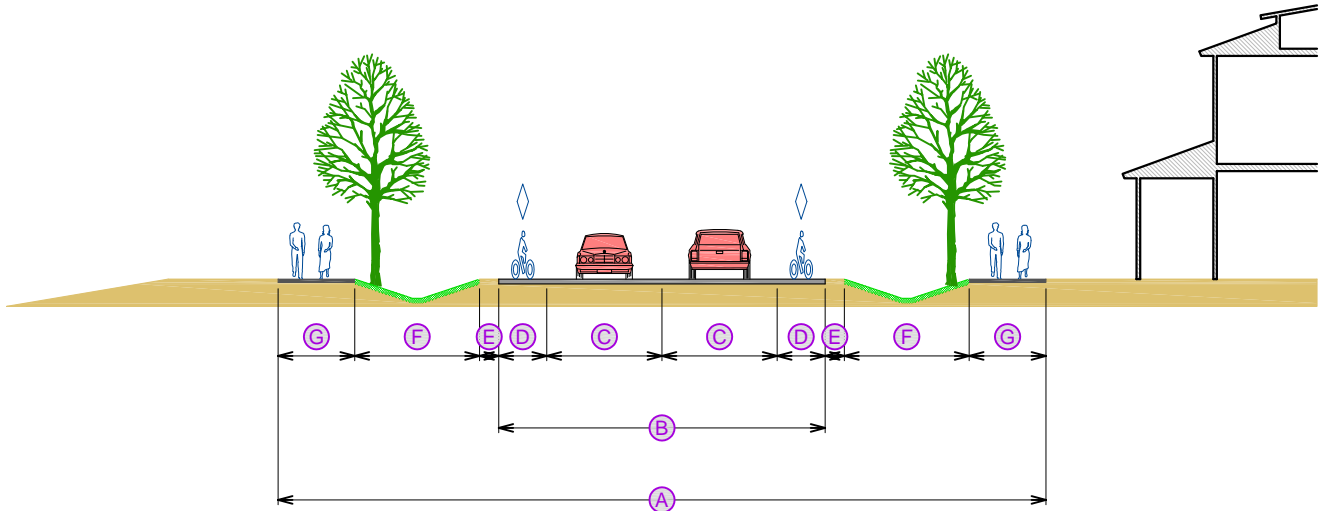

**Application**

Design / Posted Speed	25-35 mph / 25-35 mph
Typical Transect Zone	T3, T2, SD, OS

**Overall Widths**

Right-of-Way (ROW) Width <sup>1, 2</sup>	80'	(A)
Pavement Width <sup>3</sup>	32'	(B)

**Lanes**

Traffic Lanes <sup>4</sup>	2 @ 12' (2-way travel)	(C)
Bicycle Lanes	2 @ 5'	(D)
Parking Lanes	None	
Medians	None	

<sup>1</sup> Auxiliary lanes, as determined by traffic study, may require additional ROW.

<sup>2</sup> Where bike lane not required to provide area-wide connection reduce ROW by 10' and widen shoulder to 4'.

<sup>3</sup> Pavement width may widen to accommodate transit stops in locations approved by the Public Works Director.

<sup>4</sup> 11' lanes may be striped within 12' of pavement where no on-street bike lane.

**Edges**

Street Edge	2' shoulder	(E)
Planter Type / Snow	13' Landscape	(F)
Storage / Drainage		
Landscape Type <sup>5</sup>	Medium trees @ 35' o.c. avg.	
Pedestrian Lighting Type	None	
Walkway Type	8' sidewalk	(G)

**Intersection**

Curb Radius <sup>6</sup>	15'
Design Vehicle	WB 50
Pedestrian Enhancement	Concrete crosswalks at controlled collector intersections

<sup>5</sup> Trees may be clustered.

<sup>6</sup> Or as required to accommodate design vehicle and/or transit Utility easements may be required.

Connector - In Town

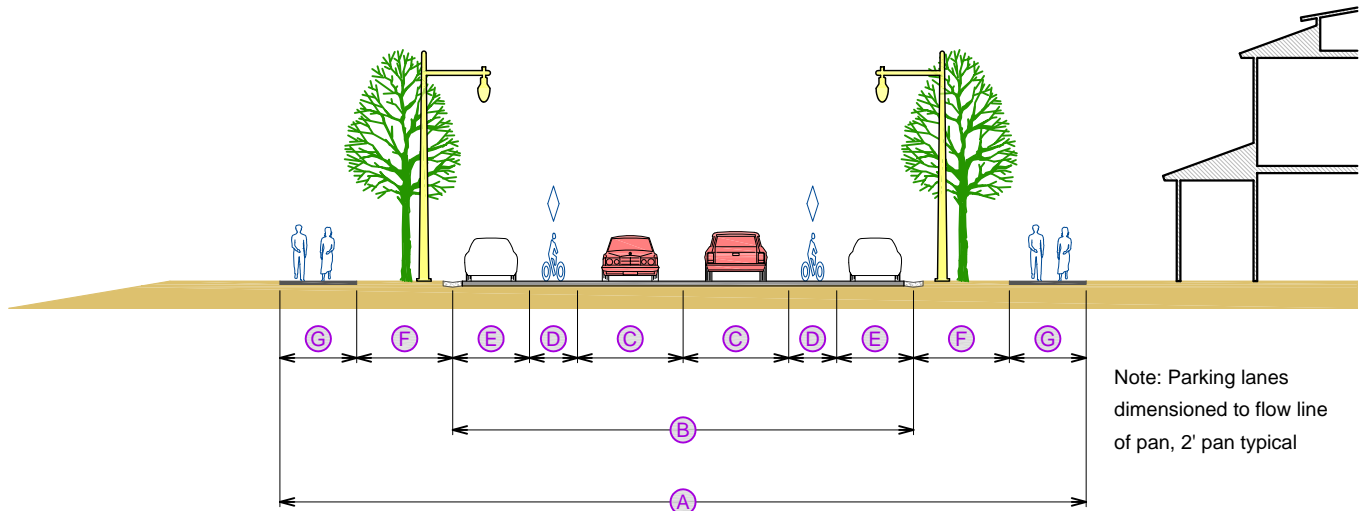

**Application**

Design / Posted Speed	25 mph / 25 mph
Typical Transect Zone	T4, T3-NG2, SD

**Overall Widths**

Right-of-Way (ROW) Width <sup>1, 2</sup>	84'	(A)
Pavement Width	48'	(B)

**Lanes**

Traffic Lanes	2 @ 11' (2-way travel)	(C)
Bicycle Lanes	2 @ 5'	(D)
Parking Lanes <sup>3, 4</sup>	2 @ 8' parallel	(E)
Medians	None	

<sup>1</sup> Where bike lane not required to provide area-wide connection reduce ROW by 10'.

<sup>2</sup> Auxiliary lanes, as determined by traffic study, may require additional ROW.

<sup>3</sup> No overnight parking during winter restricted hours.

<sup>4</sup> Transit stops are accommodated within parking lanes / landscape in locations approved by the Public Works Director.

**Edges**

Street Edge / Drainage	Valley pan
Planter Type / Snow Storage	10' Landscape (F)
Landscape Type	Medium trees @ 35' o.c. avg.
Pedestrian Lighting Type <sup>5</sup>	Post / pipe @ 100' o.c. avg.
Walkway Type	8' sidewalk (G)

**Intersection**

Curb Radius <sup>6, 7</sup>	15' (bulb-outs required)
Design Vehicle	WB 50
Pedestrian Enhancement <sup>7</sup>	Bulb outs; Concrete crosswalks at controlled collector intersections

<sup>5</sup> Street lights may be required at arterial and collector intersections.

<sup>6</sup> Or as required to accommodate design vehicle and/or transit

<sup>7</sup> Parking eliminated and width of paving reduced at intersection to decrease pedestrian crossing distance.

Utility easements may be required.

Drive - Out of Town

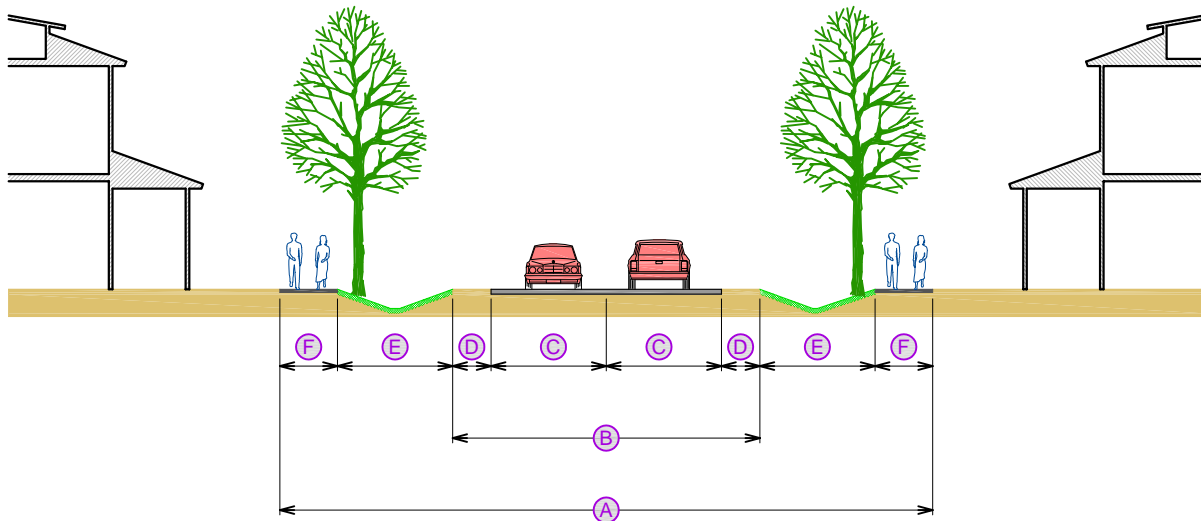

Application	
Design / Posted Speed	25 mph / 20 mph
Typical Transect Zone	T3-NG1, T2, SD, OS
Overall Widths	
Right-of-Way (ROW) Width	68' (A)
Pavement Width <sup>1</sup>	24' (B)
Lanes	
Traffic Lanes <sup>2</sup>	2 @ 12' (2-way travel) (C)
Bicycle Lanes	None
Parking Lanes	None
Medians	None

<sup>1</sup> Pavement width may widen to accommodate transit stops in locations approved by the Public Works Director.

<sup>2</sup> 11' lanes may be striped within 12' of pavement.

Edges	
Street Edge	4' shoulder (D)
Planter Type / Snow Storage / Drainage	12' (E)
Landscape Type <sup>3</sup>	Large trees @ 40' o.c. avg.
Pedestrian Lighting Type	None
Walkway Type	6' sidewalk (F)
Intersection	
Curb Radius <sup>4</sup>	15'
Design Vehicle	WB 40
Pedestrian Enhancement	None

<sup>3</sup> Trees may be clustered.

<sup>4</sup> Or as required to accommodate design vehicle and/or transit

Utility easements may be required.

No back-out driveways permitted.

Drive - In Town

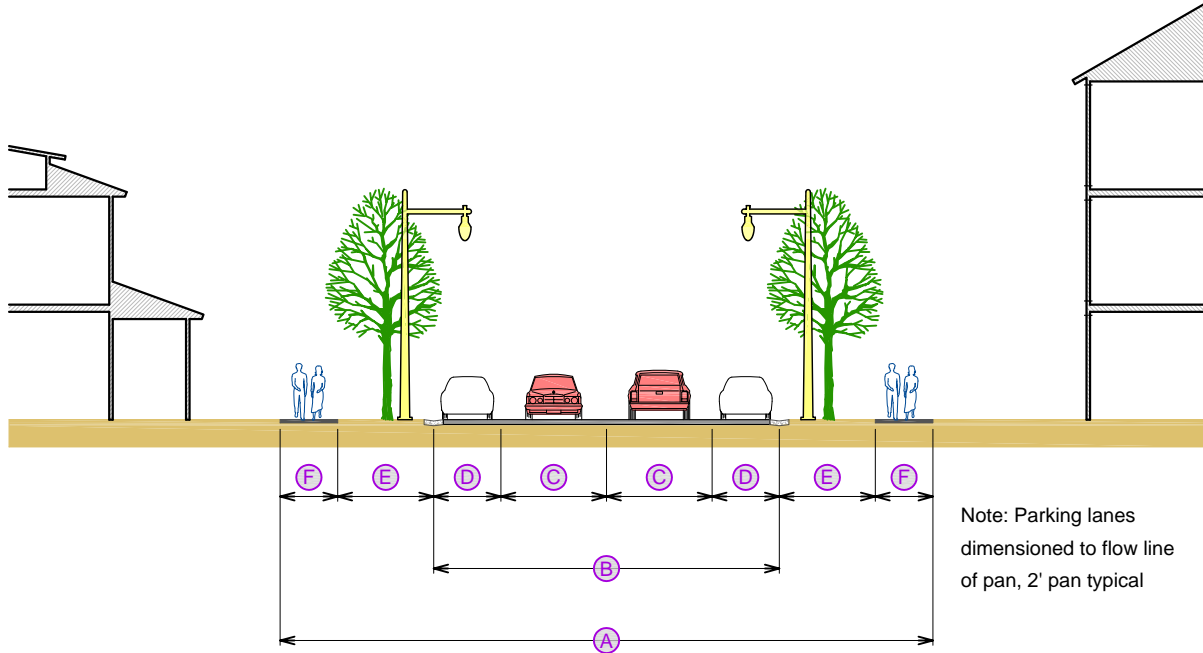

Application	
Design / Posted Speed	25 mph / 25 mph
Typical Transect Zone	T4, T3-NG2, SD
Overall Widths	
Right-of-Way (ROW) Width	68' (A)
Pavement Width	36' (B)
Lanes	
Traffic Lanes	2 @ 11' (2-way travel) (C)
Bicycle Lanes	None
Parking Lanes <sup>1, 2</sup>	2 @ 7' parallel (D)
Medians	None

<sup>1</sup> Transit stops are accommodated within parking lanes / landscape in locations approved by the Public Works Director.  
<sup>2</sup> No overnight parking during winter restricted hours.

Edges	
Street Edge / Drainage	Valley pan
Planter Type / Snow Storage	10' Landscape (E)
Landscape Type	Medium trees @ 35' o.c. avg.
Pedestrian Lighting Type	Post / pipe @ 100' o.c. avg.
Walkway Type	6' sidewalk (F)
Intersection	
Curb Radius <sup>3</sup>	15'
Design Vehicle	WB 40
Pedestrian Enhancement <sup>4</sup>	Bulb outs; Concrete crosswalks at controlled collector intersections

<sup>3</sup> Or as required to accommodate design vehicle and/or transit  
<sup>4</sup> Parking eliminated and width of paving reduced at intersection to decrease pedestrian crossing distance.  
 Utility easements may be required.

Neighborhood Street I

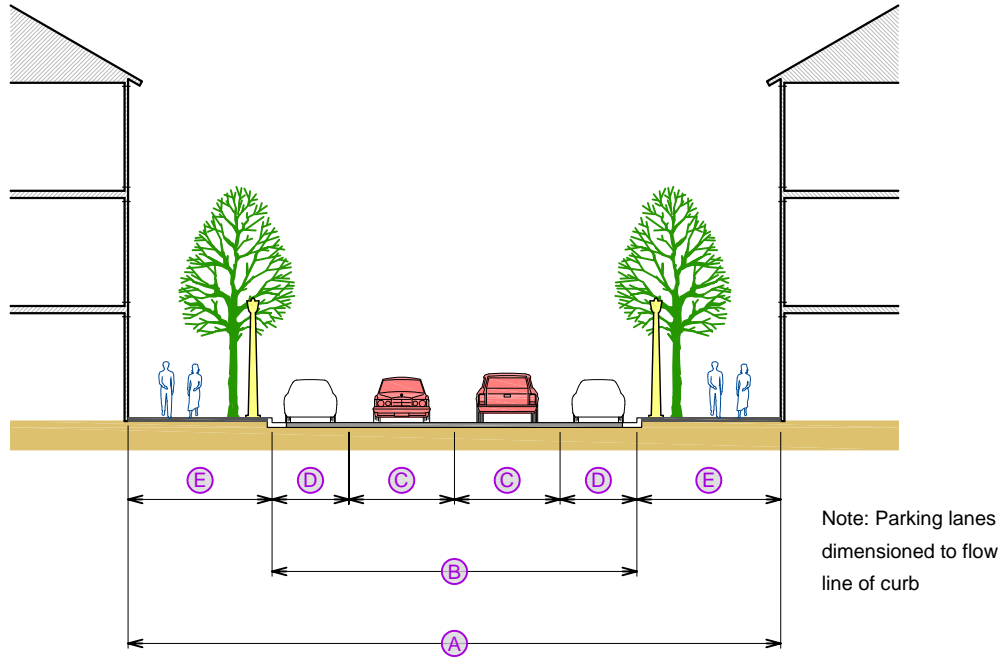

Application	
Design / Posted Speed	25 mph / 25 mph
Overall Widths	
Right-of-Way (ROW) Width	68' (A)
Curb Face to Curb Face Width	38' (B)
Lanes	
Traffic Lanes	2 @ 11' (2-way travel) (C)
Bicycle Lanes	None
Parking Lanes <sup>1, 2</sup>	2 @ 8' parallel (D)
Medians	None

<sup>1</sup> Transit stops are accommodated within parking lanes in locations approved by the Public Works Director; sidewalk width reduced by 2' to accommodate 10' transit pullout.  
<sup>2</sup> No overnight parking during winter restricted hours.

Edges	
Street Edge / Drainage	Vertical curb and gutter
Planter Type	4' x 4' tree grates
Landscape Type	Medium trees @ 35' o.c. avg.
Pedestrian Lighting Type	Single column @ 50' o.c.
Walkway Type	15' sidewalk (E)
Intersection	
Curb Radius <sup>3</sup>	15'
Design Vehicle	WB 50
Pedestrian Enhancement <sup>4</sup>	Bulb outs

<sup>3</sup> Or as required to accommodate design vehicle and/or transit  
<sup>4</sup> Parking eliminated and width of paving reduced at intersection to decrease pedestrian crossing distance.  
 Utility easements may be required.

Neighborhood Street II - Swale

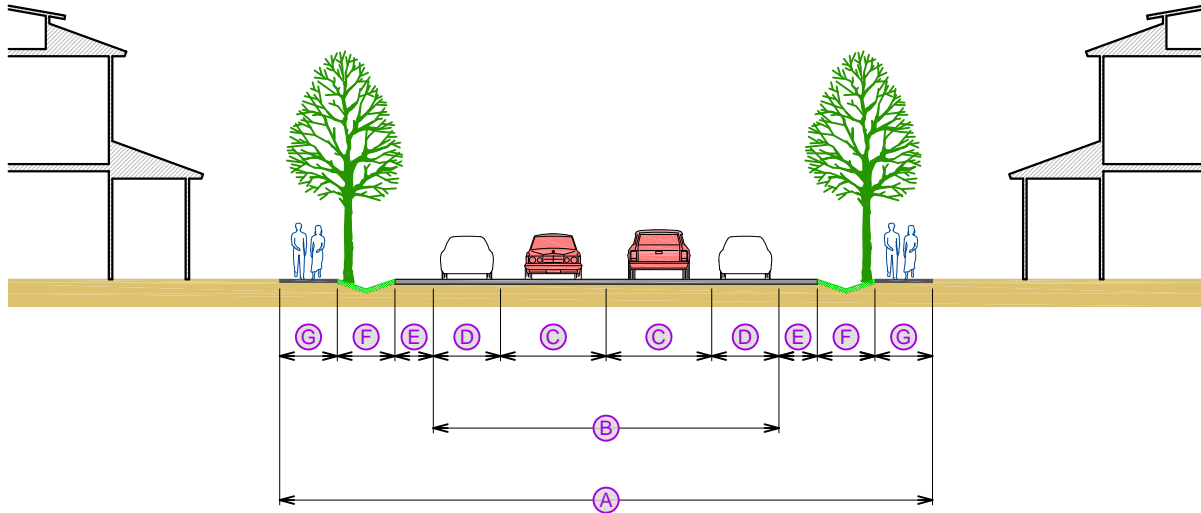

Application	
Design / Posted Speed	25 mph / 20 mph
Typical Transect Zone	T3, SD
Overall Widths	
Right-of-Way (ROW) Width <sup>1</sup>	68' (A)
Pavement Width	36' (B)
Lanes	
Traffic Lanes	2 @ 11' (2-way travel) (C)
Bicycle Lanes	None
Parking Lanes <sup>1, 2</sup>	2 @ 7' parallel (D)
Medians	None

<sup>1</sup> Parking may be provided on one side only and ROW reduced.  
<sup>2</sup> No overnight parking during winter restricted hours.

Edges	
Street Edge	4' shoulder (E)
Planter Type / Snow Storage / Drainage	6' Swale / Landscape (F)
Landscape Type <sup>3</sup>	Medium trees @ 35' o.c. avg.
Pedestrian Lighting Type	None
Walkway Type	6' sidewalk (G)
Intersection	
Curb Radius <sup>4</sup>	15'
Design Vehicle	SU 30
Pedestrian Enhancement <sup>5</sup>	Bulb outs; Where approved by Public Works Director

<sup>3</sup> Trees may be clustered.  
<sup>4</sup> Or as required to accommodate design vehicle and/or transit  
<sup>5</sup> Parking eliminated and width of paving reduced at intersection to decrease pedestrian crossing distance.  
 Utility easements may be required.  
 No back-out driveways permitted.

Neighborhood Street II - Valley Pan

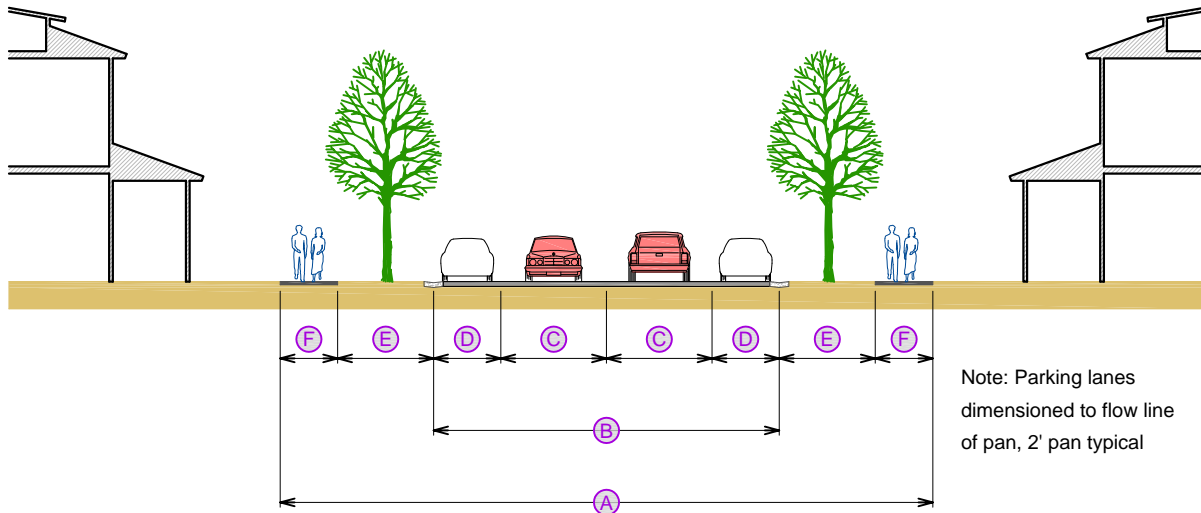

Note: Parking lanes dimensioned to flow line of pan, 2' pan typical

Application	
Design / Posted Speed	25 mph / 20 mph
Typical Transect Zone	T3, SD
Overall Widths	
Right-of-Way (ROW) Width <sup>1</sup>	68' (A)
Pavement Width	36' (B)
Lanes	
Traffic Lanes	2 @ 11' (2-way travel) (C)
Bicycle Lanes	None
Parking Lanes <sup>1, 2</sup>	2 @ 7' parallel (D)
Medians	None

<sup>1</sup> Parking may be provided on one side only and ROW reduced.  
<sup>2</sup> No overnight parking during winter restricted hours.

Edges	
Street Edge / Drainage	Valley pan
Planter Type / Snow Storage	10' Landscape (E)
Landscape Type	Medium trees @ 35' o.c. avg.
Pedestrian Lighting Type	None
Walkway Type	6' sidewalk (F)
Intersection	
Curb Radius <sup>3</sup>	15'
Design Vehicle	SU 30
Pedestrian Enhancement <sup>4</sup>	Bulb outs; Where approved by Public Works Director

<sup>3</sup> Or as required to accommodate design vehicle and/or transit  
<sup>4</sup> Parking eliminated and width of paving reduced at intersection to decrease pedestrian crossing distance.  
 Utility easements may be required.

Neighborhood Street III - Swale

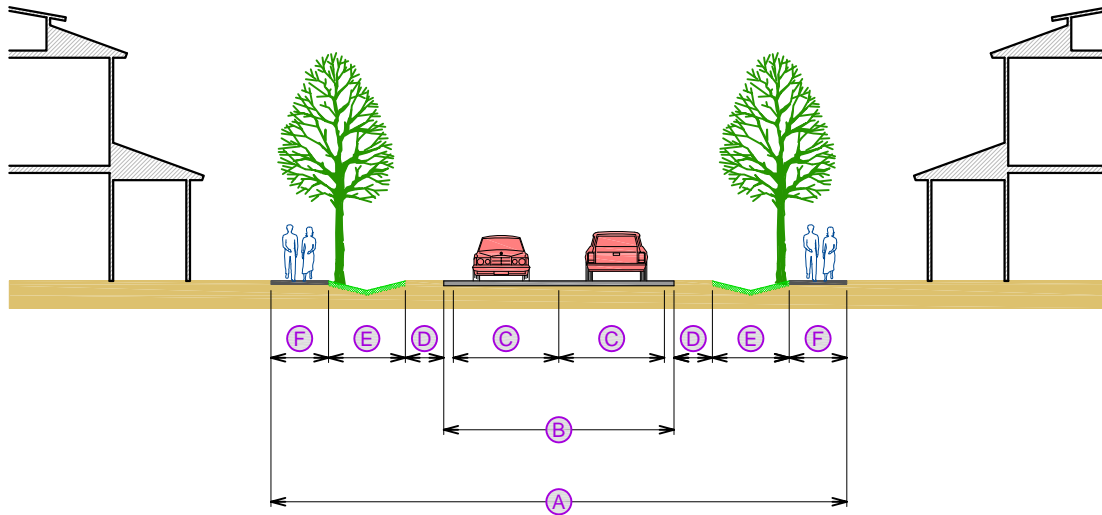

Application	
Design / Posted Speed	20 mph / 20 mph
Typical Transect Zone	T3-NG1
Overall Widths	
Right-of-Way (ROW) Width	60' (A)
Pavement Width <sup>1</sup>	24' (B)
Lanes	
Traffic Lanes	2 @ 11' (2-way travel) (C)
Bicycle Lanes	None
Parking Lanes	None
Medians	None

<sup>1</sup> 11' lanes may be striped within 12' of pavement.

Edges	
Street Edge	4' shoulder (D)
Planter Type / Snow	8' Swale / Landscape (E)
Storage / Drainage	
Landscape Type <sup>2</sup>	Medium trees @ 35' o.c. avg.
Pedestrian Lighting Type	None
Walkway Type	6' sidewalk (F)
Intersection	
Curb Radius <sup>3</sup>	15'
Design Vehicle	SU 30
Pedestrian Enhancement	None

<sup>2</sup> Trees may be clustered.  
<sup>3</sup> Or as required to accommodate design vehicle and/or transit  
 Utility easements may be required.



Neighborhood Street III - Valley Pan

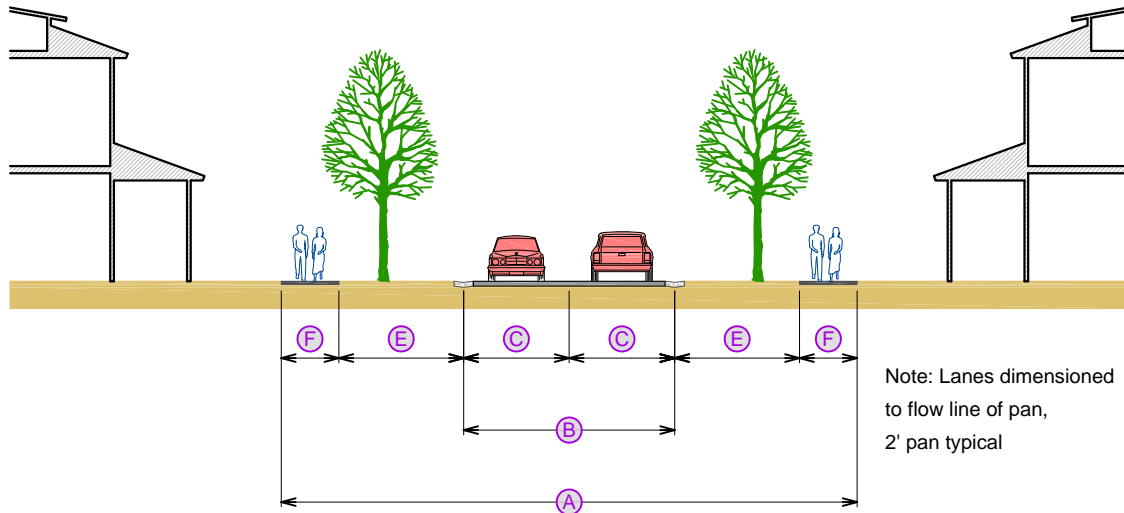

Note: Lanes dimensioned to flow line of pan, 2' pan typical

Application	
Design / Posted Speed	20 mph / 20 mph
Typical Transect Zone	T3-NG1
Overall Widths	
Right-of-Way (ROW) Width	60' (A)
Pavement Width	22' (B)
Lanes	
Traffic Lanes	2 @ 11' (2-way travel) (C)
Bicycle Lanes	None
Parking Lanes	None
Medians	None

Edges	
Street Edge / Drainage	Valley pan
Planter Type / Snow Storage	13' Landscape (E)
Landscape Type	Medium trees @ 35' o.c. avg.
Pedestrian Lighting Type	None
Walkway Type	6' sidewalk (F)
Intersection	
Curb Radius <sup>1</sup>	15'
Design Vehicle	SU 30
Pedestrian Enhancement	None
<sup>1</sup> Or as required to accommodate design vehicle and/or transit	
Utility easements may be required.	

Alley - Commercial

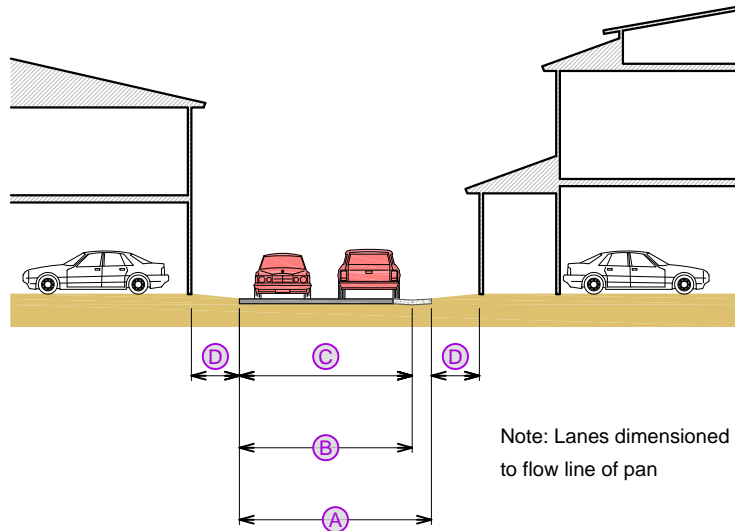

Application	
Design Speed	10 mph
Overall Widths	
Right-of-Way (ROW) Width	20' (A)
Pavement Width	18' (B)
Lanes	
Traffic Lanes	1 @ 18' (2-way travel) (C)
Bicycle Lanes	None
Parking Lanes	None
Medians	None

Edges	
Street Edge / Drainage	4' Valley pan (1-side) or (2) 2' Valley pans (both sides)
Utility / Snow Storage Easement <sup>1</sup>	5' (outside of ROW) (D)
Pedestrian Lighting Type	None
Walkway Type	None
<sup>1</sup> Pocket snow storage easements shall be provided at the ends of alleys or across the street from the end of the alley; Pocket utility easement required for above ground equipment; No fences or above ground features shall be constructed in the easement.	
Restricted maximum parking / driveway width of 24'	

Alley - Residential

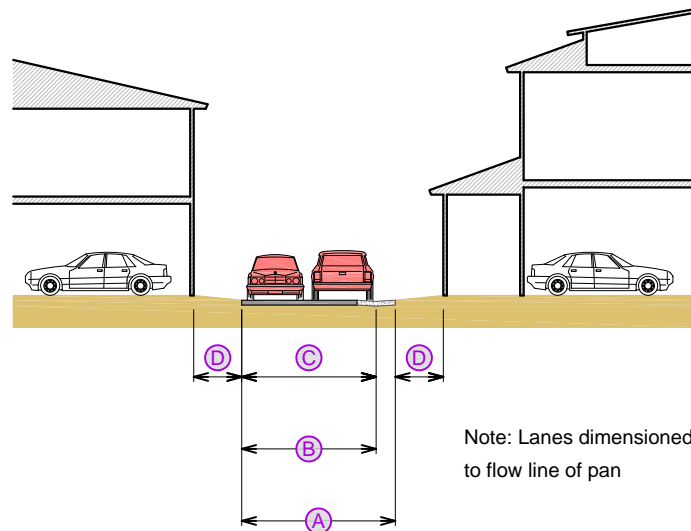

Application	
Design Speed	10 mph
Overall Widths	
Right-of-Way (ROW) Width	16' (A)
Pavement Width	14' (B)
Lanes	
Traffic Lanes	1 @ 14' (2-way travel) (C)
Bicycle Lanes	None
Parking Lanes	None
Medians	None

Edges	
Street Edge / Drainage	4' Valley pan (1-side) or (2) 2' Valley pans (both sides)
Utility / Snow Storage Easement <sup>1</sup>	5' (outside of ROW) (D)
Pedestrian Lighting Type	None
Walkway Type	None

<sup>1</sup>Pocket snow storage easements shall be provided at the ends of alleys or across the street from the end of the alley; Pocket utility easement required for above ground equipment; No fences or above ground features shall be constructed in the easement.

Restricted residential maximum parking / driveway width of 20' and (1) 10' perpendicular parking space for secondary unit

Lane

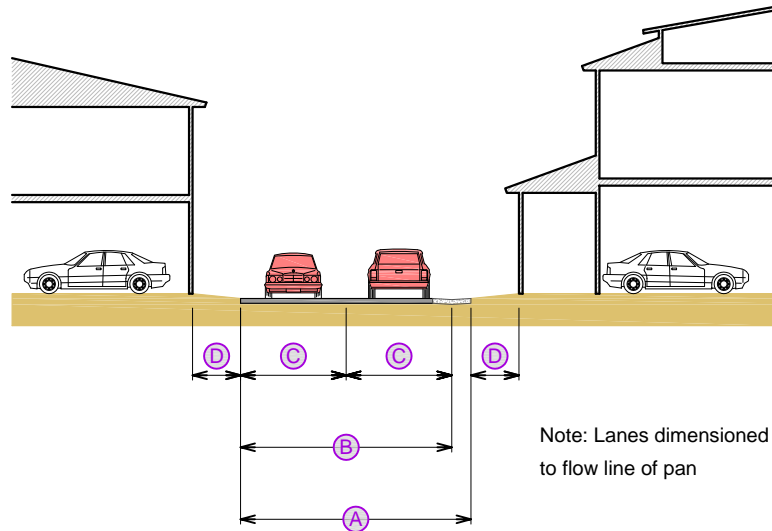

Application	
Design Speed	10 mph
Overall Widths	
Right-of-Way (ROW) Width	24' (A)
Pavement Width	22' (B)
Lanes	
Traffic Lanes	2 @ 11' (2-way travel) (C)
Bicycle Lanes	None
Parking Lanes	None
Medians	None

Edges	
Street Edge / Drainage	4' Valley pan (1-side) or (2) 2' Valley pans (both sides)
Utility / Snow Storage Easement <sup>1</sup>	5' (outside of ROW) (D)
Pedestrian Lighting Type	None
Walkway Type	None

<sup>1</sup> Pocket snow storage easements shall be provided at the ends of alleys or across the street from the end of the alley; Pocket utility easement required for above ground equipment; No fences or above ground features shall be constructed in the easement.

Restricted residential maximum parking / driveway width of 20' and (1) 10' perpendicular parking space for secondary unit.

## Appendix 4 – D Sidewalk and Trail Cross-Sections

Pedestrian Paseo

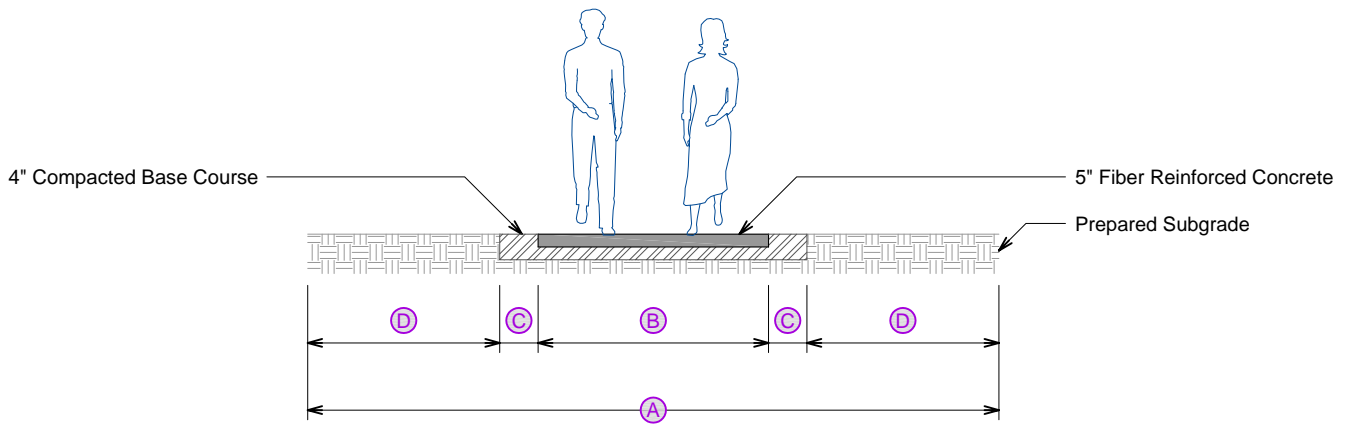

Application	
Design Speed	5 mph
Overall Widths	
Easement Width	18' min. (A)
Paved Width	6' min. (B)
Fences are not permitted within easement.	

Edges	
Drainage	None
Shoulder Type	1' (C)
Planter Type <sup>1</sup>	5' min. continuous (D)
Landscape Type <sup>1</sup>	Small trees @ 15' o.c. avg.
Pedestrian Lighting Type	None
Walkway Type	6' min.

<sup>1</sup>Planters and landscape may vary as appropriate by project location and easement width.

Primary Trail

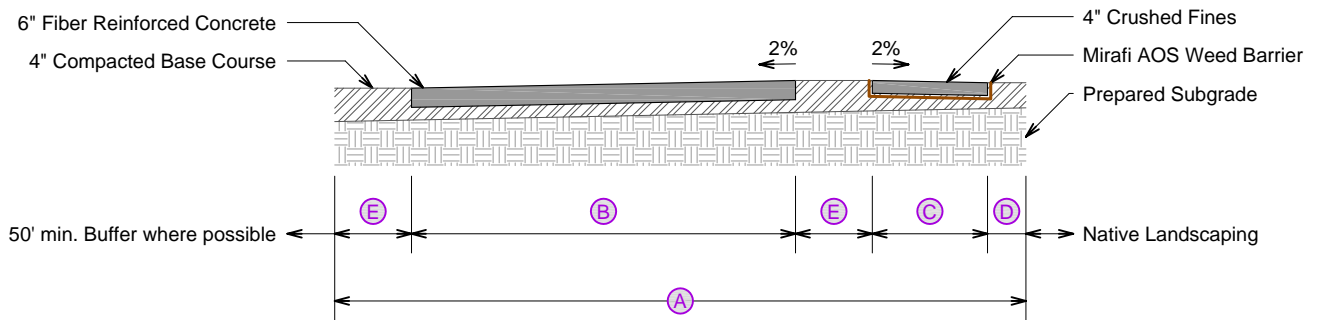

Application	
Design Speed	10 mph
Overall Widths	
Easement Width	18' min. (A)
Paved Width	10' (B)
Fences are not permitted within easement.	

Edges	
Trail Edge	3' soft surface w/ (C)
	1' shoulder on one side (D)
Drainage <sup>1</sup>	2% sideslope
Shoulder Type <sup>2</sup>	2' (E)
Landscape Type <sup>3</sup>	TBD
Pedestrian Lighting Type	None

<sup>1</sup> Drainage swales to protect uphill side of trail if uphill slope exceeds 4:1

<sup>2</sup> 2' minimum off-set between concrete trail and soft-surface trail.

<sup>3</sup> Landscape may vary as appropriate by project location and easement width.

Secondary Trail

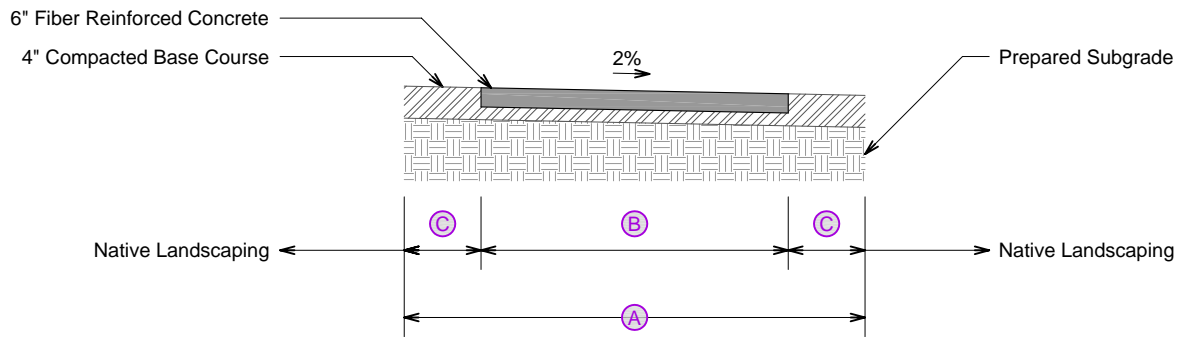

Application	
Design Speed	5 mph
Overall Widths	
Easement Width	12' min. (A)
Paved Width	8' (B)
Fences are not permitted within easement.	

Edges	
Drainage <sup>1</sup>	2% sideslope
Shoulder Type	2' (C)
Landscape Type <sup>2</sup>	TBD
Pedestrian Lighting Type	None

<sup>1</sup> Drainage swales to protect uphill side of trail (typical).

<sup>2</sup> Landscape may vary as appropriate by project location and easement width.



Soft Surface Trail

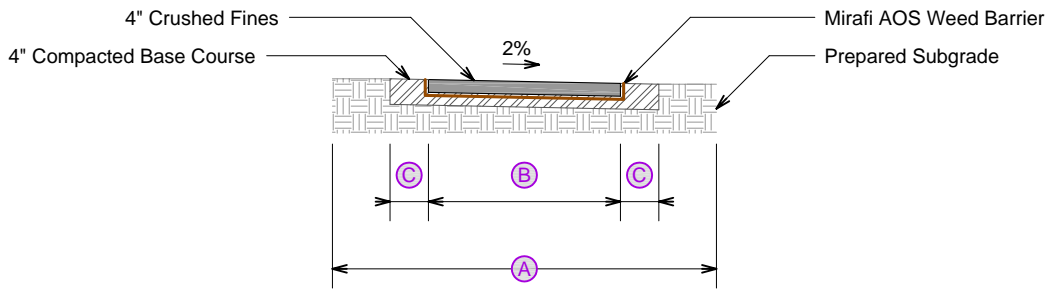

Application	
Design Speed	5 mph
Overall Widths	
Easement Width	10' min. (A)
Path Width	5' min. (B)
Fences are not permitted within easement.	

Edges	
Drainage <sup>1</sup>	2% sideslope
Shoulder Type	1' (C)
Landscape Type <sup>2</sup>	TBD
Pedestrian Lighting Type	None

<sup>1</sup> Drainage swales to protect uphill side of trail if uphill slope exceeds 4:1

<sup>2</sup> Landscape may vary as appropriate by project location and easement width.

Back Country Trail

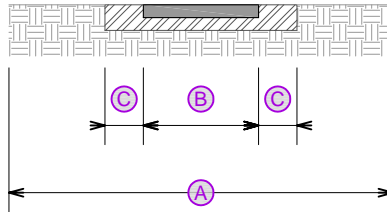

Application	
Design Speed	5 mph
Overall Widths	
Easement Width	10' min. (A)
Path Width	3' native soft surface (B)
Fences are not permitted within easement.	

Edges	
Drainage <sup>1</sup>	2% sideslope
Shoulder Type	1' native buffer (C)
Landscape Type	None
Pedestrian Lighting Type	None
<sup>1</sup> Drainage swales to protect uphill side of trail if uphill slope exceeds 4:1	

## Appendix 4-E Private Driveway Layout

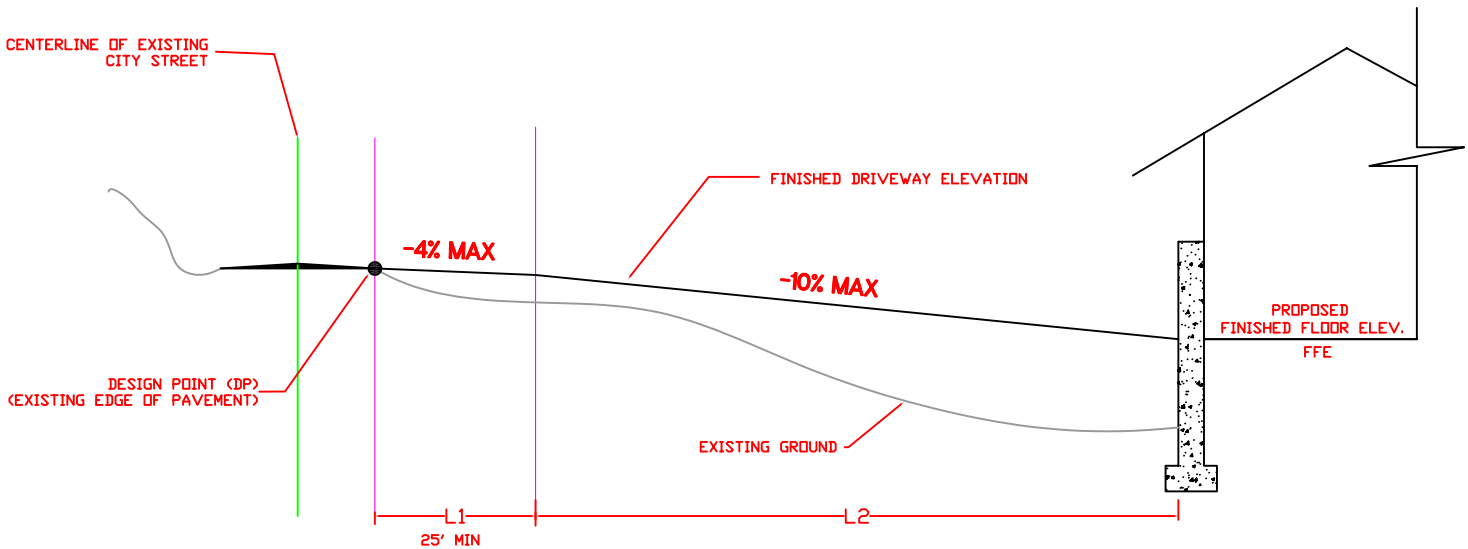

NOTE:

ANY DEVIATIONS FROM THESE STANDARDS MUST BE APPROVED BY THE CITY ENGINEER

## FINISHED FLOOR ELEVATION TO BE SET BY DRIVEWAY GRADES

EXAMPLE:

$$L1 = 25' \quad L2 = 100' \quad DPELEV = 200'$$

$$\begin{aligned} FFE &= DP + (L1 * -0.04) + (L2 * -0.10) \\ &= 200 + (25' * -0.04) + (100' * -0.10) \\ &= 200 - 1' - 10' \\ &= 189' \end{aligned}$$

City Of <b>Steamboat Springs</b> Public Works Department	DECLINED DRIVEWAY	
	Drawn by: BSB	
PO BOX 775088 STEAMBOAT SPRINGS, CO (970) 871-8216 FAX (970) 871-6306	Scale: N.T.S.	Date: 7/13/06
	Revision description:	
	Sheet number of	

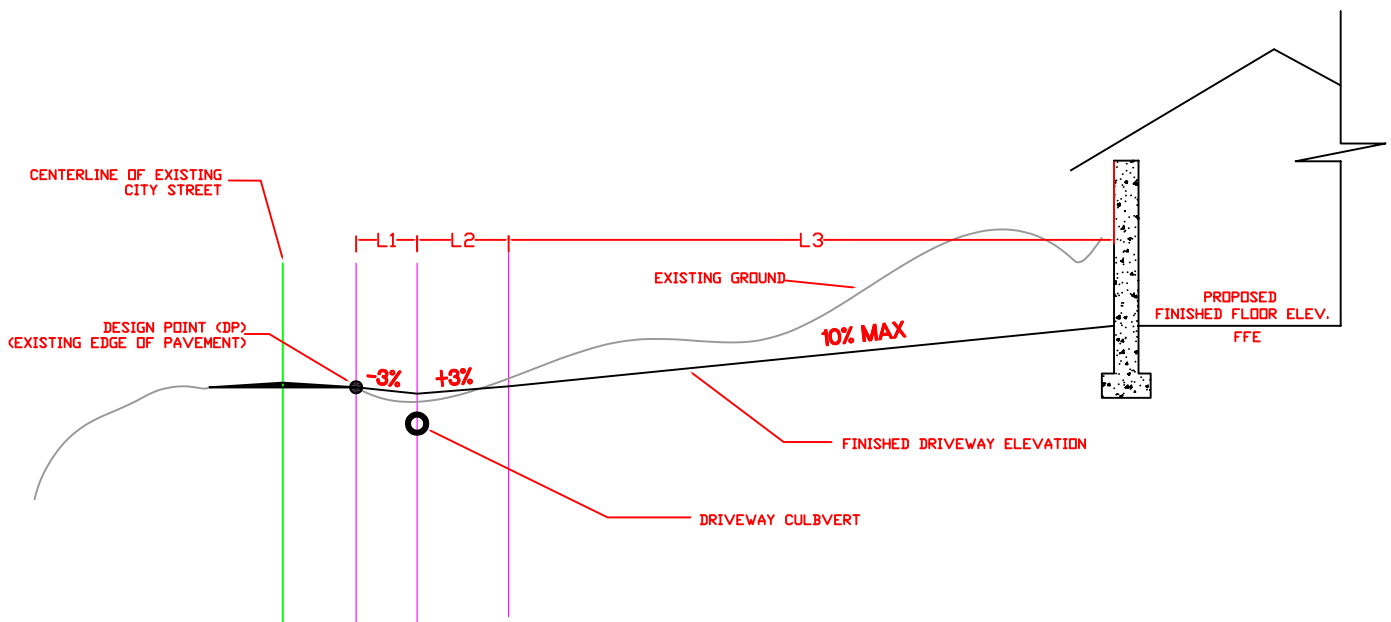

**NOTE:**

1. CULVERT MUST BE SIZED PER CITY DRAINAGE CRITERIA.
2. ANY DEVIATIONS FROM THESE STANDARDS MUST BE APPROVED BY THE CITY ENGINEER

**FINISHED FLOOR ELEVATION TO BE SET BY DRIVEWAY GRADES**

**EXAMPLE:**

$L1 = 10' \quad L2 = 15' \quad L3 = 100' \quad DPELEV = 200'$

$$\begin{aligned}
 FFE &= DP + (L1 * -0.03) + (L2 * 0.03) + (L3 * 0.10) \\
 &= 200 + (10' * -0.03) + (15' * 0.03) + (100' * 0.10) \\
 &= 200 - 0.3' + 0.45' + 10' \\
 &= 210.15'
 \end{aligned}$$

City Of <b>Steamboat Springs</b> Public Works Department	<b>INCLINED DRIVEWAY</b>	
	Drawn by: BSB	
PO BOX 775088 STEAMBOAT SPRINGS, CO (970) 871-8216 FAX (970) 871-6306	Scale: N.T.S.	Date: 7/13/06
	Revision description:	
	Sheet number of	

## Appendix 4-F Cul-D-Sac Layout

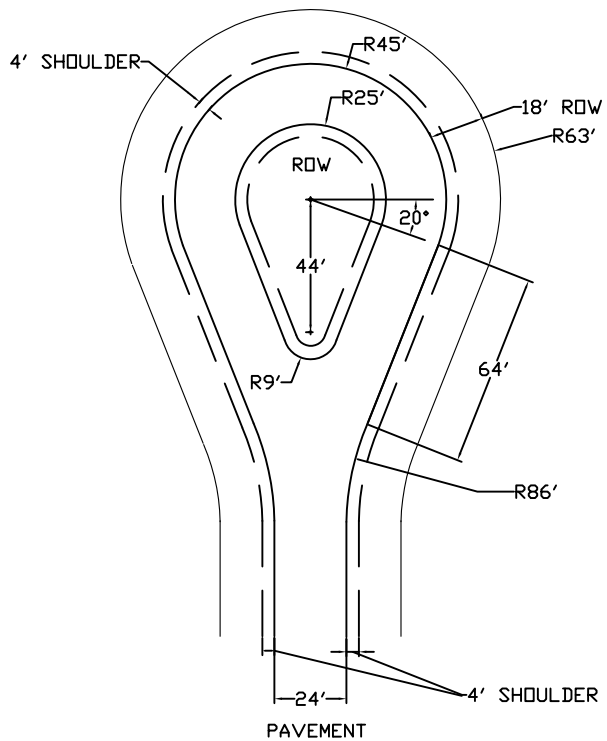

NOTE:

1. MINIMUM PARAMETERS ARE SHOWN ASSUMING IDEAL CONDITIONS BASED ON AASHTO TURNING MOVEMENTS FOR CITY TRANSIT BUS (CITY-BUS) DESIGN VEHICLE. VARIATION FROM THESE STANDARDS MAY BE REQUIRED TO ACCOMODATE ACTUAL SITE CONDITIONS.
2. CUL-DE-SAC DESIGN MUST BE APPROVED BY THE PUBLIC WORKS DIRECTOR.
3. CUL-DE-SAC APPROACH SHALL BE ALIGNED TO ENCOURAGE COUNTER-CLOCKWISE CIRCULATION. IN NO WAY SHALL THE ROADWAY APPROACH BE ALIGNED WITH THE RETURN FLOW OF THE CUL-DE-SAC.
4. ISLAND LANDSCAPING SHALL BE PRIVATELY MAINTAINED.
5. LANDSCAPING SHALL CONSIST OF NATIVE PLANT MATERIAL OR OTHER AS APPROVED BY THE PUBLIC WORKS DIRECTOR. ALL ELEMENTS MUST PROVIDE APPROPRIATE SIGHT DISTANCE FOR CUL-DE-SAC USERS.
6. CUL-DE-SAC SHALL BE MARKED ON BOTH SIDES AS A FIRE LANE INDICATED BY PERMANENT "NO PARKING - FIRE LANE" SIGNS. SIGNS SHALL HAVE A MINIMUM DIMENSION OF 12 INCHES WIDE BY 18 INCHES HIGH AND HAVE RED LETTERS ON A WHITE REFLECTIVE BACKGROUND.

City Of <b>Steamboat Springs</b> Fire & Rescue	Cul-d-Sac Layout	
	Drawn by: BSB	
PO BOX 775088 STEAMBOAT SPRINGS, CO (970) 871-8216 FAX (970) 871-6306	Scale: N.T.S.	Date: 6/27/06
	Revision description:	
	Sheet number of	

**Table 4.1 - Conventional Road Standards - Design Elements**

<b>Street Classification</b>	<b>Major Collector</b>	<b>Minor Collector</b>	<b>Local - Valley</b>	<b>Local - Ditch</b>	<b>Local - Mountain</b>
Posted Speed	35 mph	25 mph	25 mph	25 mph	25 mph/ 20 mph segments
Design Speed	40 mph	30 mph	25 mph	25 mph	25 mph/ 20 mph segments
Min. Horiz Curve Radius (w/ normal crown)	821'	353'	208'	208'	208'/110'
Min. Tangent Between Curves	120'	110'	50'	50'	0'
Max super elevation	3%	n/a	n/a	n/a	3%
Cross-slope	2 or 3%	2 or 3%	2 or 3%	2 or 3%	2 or 3%
Min Grade	1%	1%	1%	1%	1%
Max Grade	7%	7%	7%	7%	10%
Min K - Crest	44	29	12	12	12
Min K - Sag	64	49	26	26	26
<b><u>Intersection Parameters</u></b>					
Intersection spacing <sup>a</sup>	1/2 to 1/4 mile	1/2 to 1/4 mile	150'	150'	varies
Offset between major driveway (> 100 trips per day) <sup>a</sup>	300'	300'	50'	50'	150'
Offset between minor driveway <sup>a</sup>	300'	300'	25	25	25
Min Tangent Distance at Intersection	150'	150'	50'	50'	50'
Max Grade w/ in X feet of intersection	4%	4%	4%	4%	4%
Distance X from intersection	100'	100'	50'	50'	50'
Min. Sight Distance (Stopping)	305'	200'	155'	155'	155'
Intersection angle/variability <sup>b</sup>	90/10	90/10	90/30	90/30	90/30

Note: For US 40 See CDOT Access Code and other CDOT guidelines

a) Measured centerline to centerline; greater distance may be required by TIS

b) Variability allowed with approval, sight distance must be provided.



Table 4.2 Urban Street Design Elements

	Major Collector				Minor Collector	
Street Type	Boulevard - in town	Boulevard out town	Parkway - Intown	Parkway - outtown	Connector - intown	Connector - Outtown
General Use Description	US 40 to NVP	US 40 to NVP adjacent to town center	along NVP in Village Center	along NVP not in Village Ctr	provides connections between pods, US40, nvp, and surrounding area	provides connections between pods, US40, nvp, and surrounding area
Typical Transect Zones	T5	T5	T4, T5	T3, T2, SD, OT	T4-nc, T3-ng2, SD	T2-ne, T3- ng1, SD, OT
Posted Speed	25 mph	25	25	25 - 35	25	25 - 35
Design Speed	25 mph	25	25	25 - 35	25	25 - 35
Min. Horiz Curve Radius (w/ normal crown)	200'	200'	200'	510	200'	510
Min. Tangent Between Curves	50'	50'	50'	100'	50'	50'
Max super elevation	3%	3%	3%	0	n/a	n/a
Cross-slope	3%	3%	3%	3%	3%	3%
Min Grade	1%	1%	1%	1%	1%	1%
Max Grade	7%	7%	7%	7%	7%	7%
Min K - Crest	12	12	12	29	12	29
Min K - Sag	26	26	26	37	26	37
<b>Intersection Parameters</b>						
Minimum Street Intersection spacing <sup>a</sup>	1/2 to 1/4 mile; or 600 ft in Town Center	1/2 to 1/4 mile; or 600 ft in Town Center	1/2 to 1/4 mile; or 600 ft in Town Center	1/2 to 1/4 mile; or 600 ft in Town Center	1/4 mile; or 600 ft in TND	1/4 mile; or 600 ft in TND
Offset between major driveway (> 100 trips per day) <sup>a</sup>	300'	300'	150'	150'	150'	150'
Offset between minor driveway <sup>a</sup>	150'	150'	150'	150'	75'	75'
Min Tangent Distance at Intersection	200	200	150'	150'	100'	100'
Max Grade w/ in X feet of intersection	4%	4%	4%	4%	4%	4%
Distance X from intersection	100	100	50'	50'	50'	50'
Min. Sight Distance (Stopping)	155'	155'	155'	250'	155'	250'
Intersection angle/variability <sup>b</sup>	90/10	90/10	90/30	90/30	90/30	90/30

Notes:

a) Measured centerline to centerline; greater distance may be required by TIS

b) Variability allowed with approval, sight distance must be provided.

Table 4.2 Urban Street Design Elements

	Local						
Street Type	Drive - in town	Drive - out town	Neighborhood I	Neighborhood II - valley	Neighborhood II - ditch	Neighborhood III - valley	Neighborhood III - ditch
<b>General Use Description</b>	see map - secondary connections	loop drive	within town center, neighborhood centers, and adjacent Special Districts	in residential areas moderate to lower density	in residential areas lower density	residential low density	residential low density
Typical Transect Zones	T4- NC, T3 - NG2, SD	T3 - NG2, T2- NE	T4-NC, SD, T5-TC	T3-NG2,T3-NG1, T2-NE, SD	T3-NG2,T3-NG1, T2-NE, SD	T3-NG1, T2-NE	T3-NG1, T2-NE
Posted Speed	25	25	25	20	20	20	20
Design Speed	25	25	25	25	25	20	20
Min. Horiz Curve Radius (w/ normal crown)	200'	200'	200'		200'	110	110
Min. Tangent Between Curves	50'	50'	50'	none	none	none	none
Max super elevation	n/a	n/a	n/a	n/a	n/a	n/a	n/a
Cross-slope	3%	3%	3%	3%	3%	3%	3%
Min Grade	1%	1%	1%	1%	1%	1%	1%
Max Grade	7%	7%	7%	7%	7%	7%	7%
Min K - Crest	12	12	12	12	12	7	7
Min K - Sag	26	26	26	26	26	17	17
<b>Intersection Parameters</b>							
Minimum Street Intersection spacing <sup>a</sup>	600'	600'	600'	300'	300'	300'	300'
Offset between major driveway (> 100 trips per day) <sup>a</sup>	50'	50'	50'	50'	50'	50'	50'
Offset between minor driveway <sup>a</sup>	50'	50'	25'	25'	25'	25'	25'
Min Tangent Distance at Intersection	50'	50'	50'	50'	50'	50'	50'
Max Grade w/ in X feet of intersection	4%	4%	4%	4%	4%	4%	4%
Distance X from intersection	50'	50'	50'	50'	50'	50'	50'
Min. Sight Distance (Stopping)	155'	155'	155'	155'	155'	115'	115'
Intersection angle/variability <sup>b</sup>	90/30	90/30	90/30	90/30	90/30	90/30	90/30
Notes:							
a) Measured centerline to centerline							
b) Variability allowed with approval,							

**Table 4-3 - Private Driveway Standards**

Classification	Residential Driveway - 1 unit	Residential Driveway - 2 units	Residential Driveway - 3 or 4 units	Residential Private Street	Commercial/Industrial Private Access
<b>Layout Parameters</b>					
Minimum Width (a)	10'/12'	12'/16'	20/24'	24'	24'
Maximum Width	24' (j)	24'	24'	24'	32'
Maximum Centerline Slope (b)	10%	10%	7%	7%	7%
Staging Area Length - site lower than access road	25'	25'	50'	75'	75'
Staging Area Slope - site lower than access road	4%	4%	4%	4%	4%
Staging Area Slope/length - site higher than access road (c)	10' @ -3%, 15' @ +3%	10' @ -3%, 15' @ +3%	10' @ -3%, 15' @ +3%	10' @ -3%, 15' @ +3%	10' @ -3%, 15' @ +3%
Pavement Return Radius at street (d)	0 – 5'	0 – 5'	0 – 10'	0 – 15'	0 – 25'
Minimum Horizontal Curve along Centerline (e)	15'/61'	15'/51'	15'/ 80'	15'	20'
Vertical Clearance	13.5'	13.5'	13.5'	16'	16'
Surface (f)	Paved	Paved	Paved	Paved	Paved
Pavement Design (g)	tbd by geotechnical report				
Turnaround Required at dead end (h)	if > 150 ft	if > 150 ft	if > 150 ft	if > 150 ft	if > 150 ft
Intersection Angle/Variability	90/30	90/30	90/30	See Table 4.1	90/30
Backout onto Street	permitted onto local; not permitted onto collector or arterial	permitted onto local; not permitted onto collector or arterial	permitted onto local; not permitted onto collector or	not permitted	not permitted
Snow Storage (1 ft storage: 2 ft pavement)	Yes	Yes	Yes	Yes	Yes
Offset From Local Street (i)	50	50	50	50	50
Offset from Collector Street	50	50	150	150	150
Offset from Arterial Street	150	150	150	300	300
Offset from Adjacent Driveway	10	10	10	same as adjacent street	same as adjacent street
Note: For US 40 See CDOT Access Code and other CDOT guidelines; Standards reference Fire Prevention Services Policy 4.1.1 dated ? ; confirm requirements with Fire Marshall					
a) Value listed is pw minimum/ fire dept minimum. Check with Fire Marshall to determine if driveway is considered a fire apparatus access road and needs to meet fire dept minimum.					
b) Slope may be up to 12% for lengths less than 100 ft or 1/3 of the driveway (whichever is less) for 1 or 2 units; up to 10% for lengths less than 100 ft or 1/3 the driveway (whichever is less) for common driveways, and up to 10% for lengths less than 50 ft for private access (residential or commercial) permitted provided staging area requirements are met. If heated driveway is installed, slope may be up to 12%.					
c) Distance to transition may vary to correspond to existing ditch location					
d) Maximum curb radius for commercial access in TND to match the maximum curb radius for the adjacent street category.					
e) Driveways must be designed to accommodate the identified design vehicle. Value listed is pw minimum/ fire dept minimum. Check with Fire Department to determine if driveway/access is considered a fire apparatus access road and needs to meet fire criteria.					
f) Paved surface shall be asphalt, concrete, or equivalent hard surface material approved by the City Engineer. Porous pavement or alternate paving materials intended for stormwater quality management are encouraged and may be utilized with City Engineer approval. Recycled asphalt is only acceptable as a temporary fire access surface. Residential Driveways 1 and 2 shall be paved within 1 year of construction completion. Multifamily, industrial, and commercial access shall be paved prior to issuance of the first certificate of occupancy.					
g) In lieu of geotechnical report, pavement for residential driveway or private/commercial access without fire access is minimum is 4" road base with 3" asphalt, minimum residential or commercial access with fire access is 8" pit run, 4" road base, and 4" asphalt.					
h) Turnaround to meet Fire Dept stds; fire accesses greater than 200 ft in length and less than 20 ft in width shall be provided with turnouts per fire code in addition to turn around					
i) If lot is smaller than required offset, edge of access shall be 5ft from far lot line. If access offset is measured along an alley, minimum offset is 25 feet from intersection					
j) If access off alley with secondary unit, maximum width is 30feet as long as snow storage area is identified along alley 5 feet deep by 20 feet either side of access					